

Fuse Box

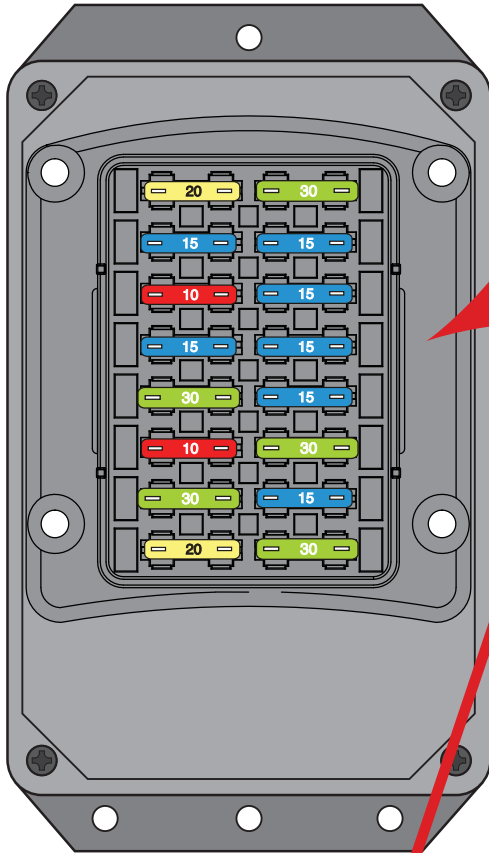

Fuse Box Lid



NOTE:

If your fuse box and fuse box lid look like this, these **ARE** the correct instructions for your application. If the word "BUSSMANN" appears on your fuse box or fuse box lid, you have an earlier version of this kit and these **ARE NOT** the correct instructions.

KIT BOX CONTENTS:

Number	Description
510476	Alternator and Main Power Connection Kit
510888	Main Dash Harness Kit w/ AAW Fuse Panel
510638	Front Light Wiring Kit
510639	Rear Body Wiring Kit
510640	Console Wiring Kit
510730	Vehicle Speed Sensor (VSS) Lead Wires
510783	Engine Wiring Kit
510785	Instrument Cluster Wiring Kit
500042	Dimmer Switch
500557	Fuse, Relay & Flasher Kit
500919	Practice Terminal Kit
92973563	Kit Introduction Instructions for AAW Fuse Panel
92971552	Firewall Modification Template
92973602	Warning Sheet



**American
Autowire**

www.americanautowire.com 856-933-0801

Classic Update Kit
1968-70 MOPAR B BODY

510634

92973790 Rev. 0.0 03/22/2024

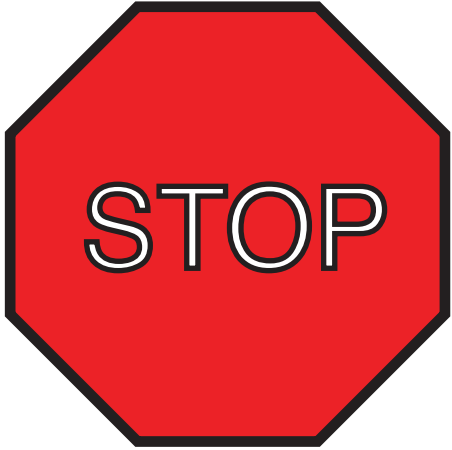

WARNING:

Validate the kit contents with the component list included on page 2 of this sheet before proceeding. This kit is intended to be used in a modified vehicle. Please read this sheet thoroughly and be sure that you understand everything explained on it prior to opening any of the enclosed packages, or before attempting to install any of the components. Once this kit has been opened or a component installed, the kit is not returnable.

1. This kit should typically be used in a **MODIFIED** application only. This kit does not contain any wiring for, nor will it support the use of some of the more obscure factory options such as headlight delay, headlights-on warning buzzer, heated rear window, etc. The original OEM dash harness wiring for any of the factory equipped A/C cars varied from year to year. None of that wiring is included with this kit, and therefore, this kit **WILL NOT** support the use of any Factory installed A/C set up. However, this kit does supply power for any aftermarket A/C or Heater System.
2. **NOTE:** There is no wiring in this kit for the electric headlight motors used on the 1970 Dodge Charger hideaway headlight system, nor does this kit support that system in any way. It will support the vacuum operated systems used on the 1968 and 1969 Chargers, and also the Superbird and Daytona cars.
3. This kit only supports the use of a higher current, self-exciting 1-wire alternator or an internally regulated alternator. The use of the factory externally regulated alternator is not supported with this kit.
4. This kit **WILL NOT** support the use of a factory ammeter. All AAW kits are engineered to supply the optimum charge to the battery. To achieve this performance, we route our 6 Gauge charge wire directly from the alternator output terminal to the Starter Relay Battery terminal. Due to the path of the charge being altered from the stock configuration, the gauge can no longer see a charge vs. a discharge, so it will not work properly. When ammeters were originally used, most generator or alternator current outputs were rated at a maximum of about 25-60 amps. Modified cars being built today typically utilize a 100 amp or higher output alternator. With these higher current units, ammeters, generally speaking, become a safety hazard. Ammeters are usually wired in parallel to the charging circuit, are typically unfused, and can short very easily causing a fire. A voltmeter is recommended as a good alternative.
5. This kit is wired with a full 12 volt primary ignition feed that is hot in the run position. Primary ignition voltage in the starting position is handled via a full 12 volt bypass wire. Our system will support HEI, MSD, other electronic ignition systems, as well as most all computerized Fuel Injection systems. If you wish to run a points type system, there are illustrations on the engine connection pages to do so. The connectors and terminals to install a ballast resistor for a points type system are included in this kit, but extra parts (ballast resistor) that are not included in this kit will be required to complete that operation.



www.americanautowire.com 856-933-0801

510634

92973602 Rev 0.0 6/4/2021

510634 - Classic Update Series Kit 1968-70 Mopar B-body

This kit contains the following components:

<u>Bag</u>	<u>Part Number</u>	<u>Description</u>	<u>Quantity</u>
	500042	Floor Dimmer Switch	1
	500919	Practice Terminal Crimping Set	1
	510557	Fuse, Relay, and Flasher Kit	1
G	510888	Dash Harness Kit	1
H	510785	Dash Cluster wiring kit	1
J	510783	Engine Wiring Kit	1
L	510638	Front Light Wiring Kit	1
M	510639	Rear Body Wiring Kit	1
C	510640	Floor Console Kit	1
V	510730	VSS Connection Kit	1
Z	510476	Alternator and Main Power Connection Kit	1
	92973563	Kit Introduction Instruction Sheet	1
	92973602	Warning Sheet	1
	92971552	Firewall Modification Template	1

Validate the kit contents with this component list. If there are any discrepancies with incorrect or missing parts, stop your installation and notify the supplier you purchased the kit from before proceeding.



www.americanautowire.com 856-933-0801

510634

92973602 Rev 0.0 6/4/2021

Classic Update Series

1968-70 Mopar B-Body

START HERE !

PLEASE READ THIS BEFORE STARTING INSTALLATION !

This wiring kit is designed for ease of installation. Please read the guidelines below, BEFORE STARTING your installation, to guarantee a successful job. Use an appropriate crimping tool, which folds the wings of the open barrel terminals down into the wire, as shown on this page. If you use our crimping tools and correctly crimp the included terminals, soldering is not necessary. If you are unsure about a particular crimp, soldering is recommended. Our factory crimped terminations are installed by GM approved five ton presses, and soldering these terminations is not necessary.

AAW offers a great terminal crimping video entitled "Proper Crimping Video". It can be viewed by visiting YouTube.

Youtube Channel:
www.youtube.com/user/WiringHarness



Type the following address into your web browser, to go directly to the video: <https://www.youtube.com/watch?v=JAgEDoVI-co>

AS THIS HARNESS IS DESIGNED FOR USE IN A MODIFIED CAR, REQUIRING A HIGHER RATE OF CHARGE, IT DOES NOT SUPPORT THE USE OF A STOCK (ORIGINAL) ALTERNATOR. IT IS DESIGNED FOR USE WITH A SINGLE WIRE STYLE INTERNALLY REGULATED ALTERNATOR.

STEP 1: DISCONNECT YOUR BATTERY:

Disconnect the battery before installing the wiring kit to prevent any accidental shorting caused by loose bare wire ends.

STEP 2: START INSTALLING KIT:

This kit is broken down into individual steps that are identified by a letter printed on the instruction sheets visible through each bag. These letters are the order of operation for installing your kit. Start with bag letter **G**, then **H**, etc. The order of installation is shown below.

- G - 510888 Dash Harness Kit
- C - 510640 Floor Console Kit
- H - 510785 Gauge Cluster Kit
- M - 510639 Rear Body Kit
- L - 510638 Front Light Kit
- J - 510783 Engine Kit
- Z - 510476 Alternator and Main Power Connection Kit
- V - 510730 VSS CConnection Kit

STEP 3: RECONNECT YOUR BATTERY:

When you have completed the installation and are ready to reconnect the battery, make sure that the following electrical system grounds are in place:

- A. Battery is grounded to the ENGINE BLOCK.
- B. Battery is grounded to the frame.
- C. Engine block is grounded to the frame.
- D. Body is grounded to the frame.

STEP 4: CHECK ALL ELECTRICAL FUNCTIONS:

Any non-functioning items should be checked for proper installation. Any problems with your wiring and electrical circuit functions should be addressed to American Autowire Systems, Inc. as soon as possible to avoid any warranty problems.

If you have any questions concerning this or any of our products, please feel free to call us at 1-856-933-0801.

AMERICAN AUTOWIRE MAKES IT EASY !!

The terminals that we supply in our kits, utilize what is known as an F crimp. The F crimp, in a cross section, will look like the illustration below, when done correctly.

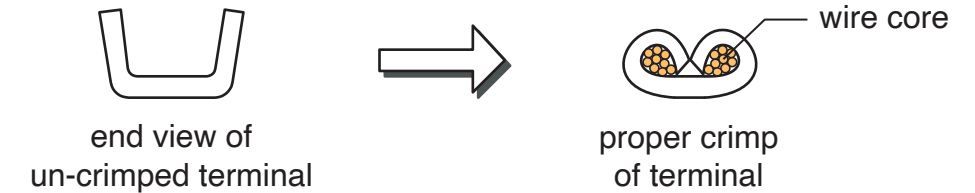

We carry many accessories for your 1968-70 MOPAR B-BODY

We carry the following crimping hand tools, to help with your terminal crimping. These hand tools are available, for purchase or rental.

p/n 510585
OEM small terminal crimping tool (18-14 gauge)

p/n 510586
OEM large terminal crimping tool (12-8 gauge)

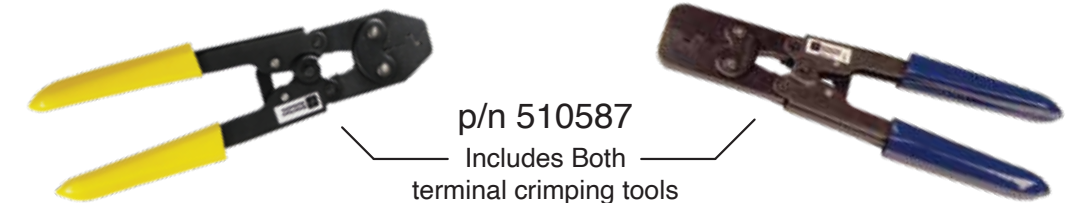

p/n 510587
Includes Both terminal crimping tools



p/n 510430
Map Light Harness



p/n 500100
Door Jamb Switch, self-tapping (fits a 3/8"-24 hole)



p/n 500236
Billet Aluminum Knob (fits a 3/16" shaft)



p/n 500235
Billet Aluminum Knob (fits a 1/4" shaft)



www.americanautowire.com 856-933-0801

1968-70 Mopar B-Body
Classic Update Series
510634

© COPYRIGHT 2004 American Autowire / Factory-Fit
Used with express permission of
American Autowire / Factory-Fit
92973563 Rev 0.0 2/22/2022

THIS PAGE HAS INTENTIONALLY BEEN LEFT BLANK



1968-70 Mopar B-Body
Classic Update Series
510634

© COPYRIGHT 2004 American Autowire / Factory-Fit
Used with express permission of
American Autowire / Factory-Fit
92973563 Rev 0.0 2/22/2022

Template for modification of the firewall on a 1968-70 Mopar B-Body with a Classic Update Kit

Note: Please confirm all measurements on this template before cutting or drilling any holes.

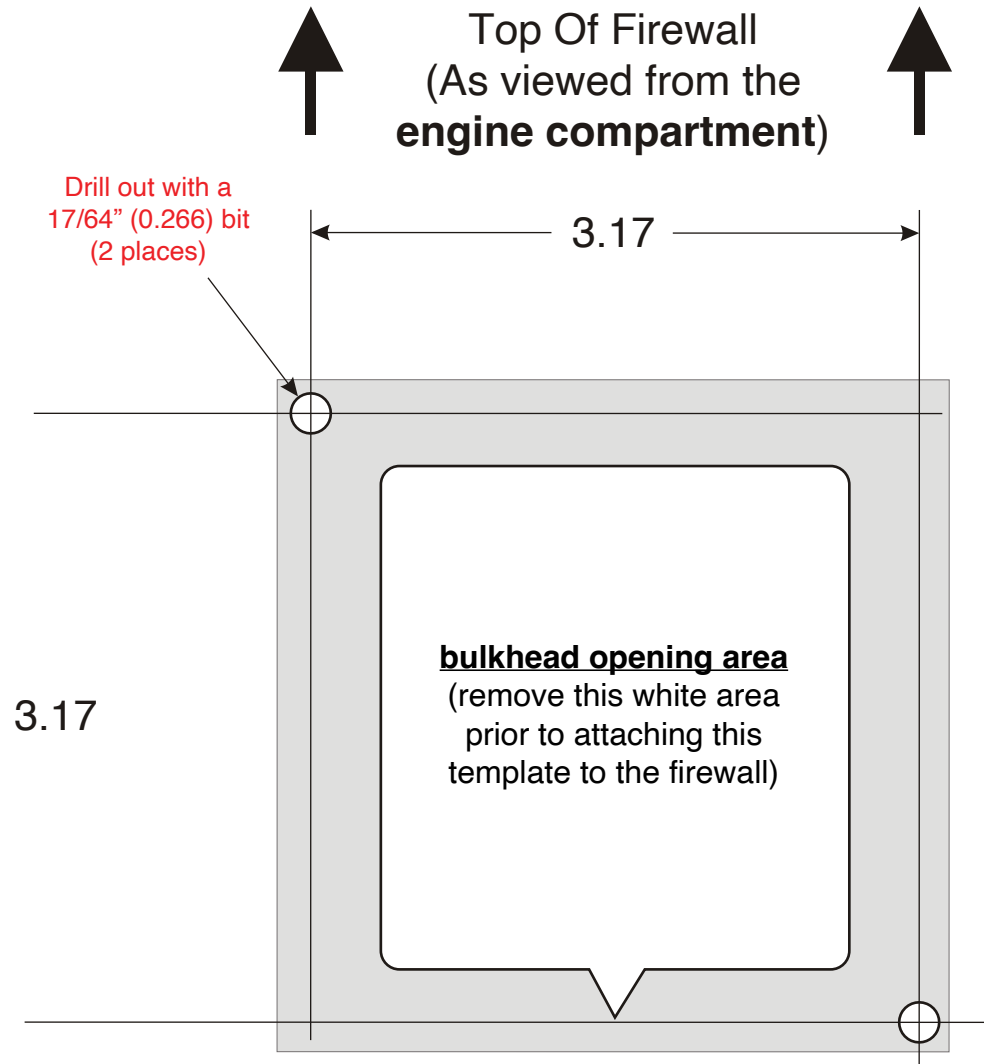

The only firewall modification needed with this new kit is to drill 2 new 0.266 mounting holes. The stock opening in the firewall is already the proper size for the new bulkhead assembly to fit through. This template can be affixed directly to the firewall or it can be applied to a stiff piece of cardboard or thin plastic, then mounted to the firewall. Be sure to clean any wax, grease, or oil from the area so that the template will stick.

1. Remove the white "bulkhead opening area" from the template and align this open area with the factory firewall opening, from the engine compartment.
2. Mark the 2 screw holes that need to be drilled out, onto the firewall using a marker or other similar means.
3. Using a center punch, slightly dimple the 2 screw marks that you have transferred onto the firewall so that your drill will not walk when making the new holes. Re-check your 2 marked areas with the template to be sure that they are correct before drilling the 2 new holes.
4. Drill your new mounting holes.
5. Using the provided screws, washers, and locking nuts found in the loose piece kit for the 510635 Dash Harness, from inside the car, install the screws and washers through the bulkhead assembly, then through the firewall. Use the washers and nuts on the engine compartment side to complete the installation.
6. Your mounting procedure is now complete. You may now continue with the installation of your Dash Harness.

PRINT ON ADHESIVE LABEL SHEET

92971552

92971552 instructions Rev 1.0 9/19/2024

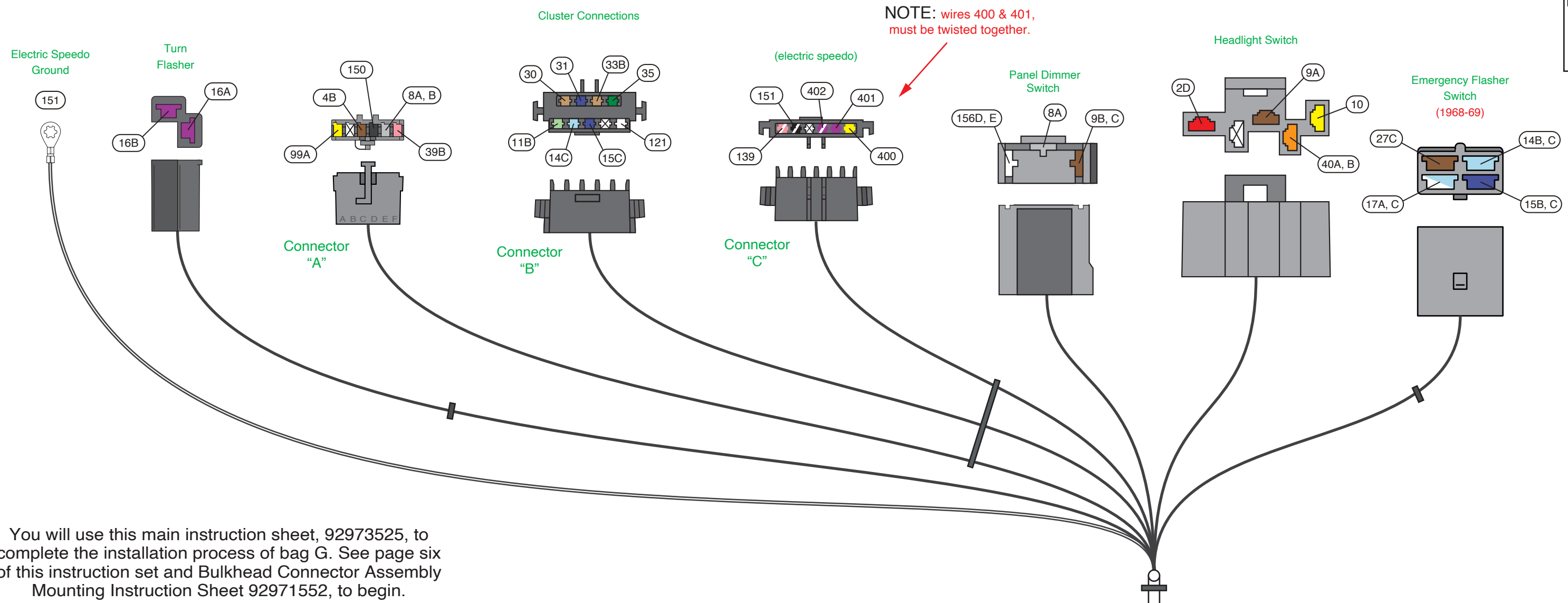

You will use this main instruction sheet, 92973525, to complete the installation process of bag G. See page six of this instruction set and Bulkhead Connector Assembly Mounting Instruction Sheet 92971552, to begin.

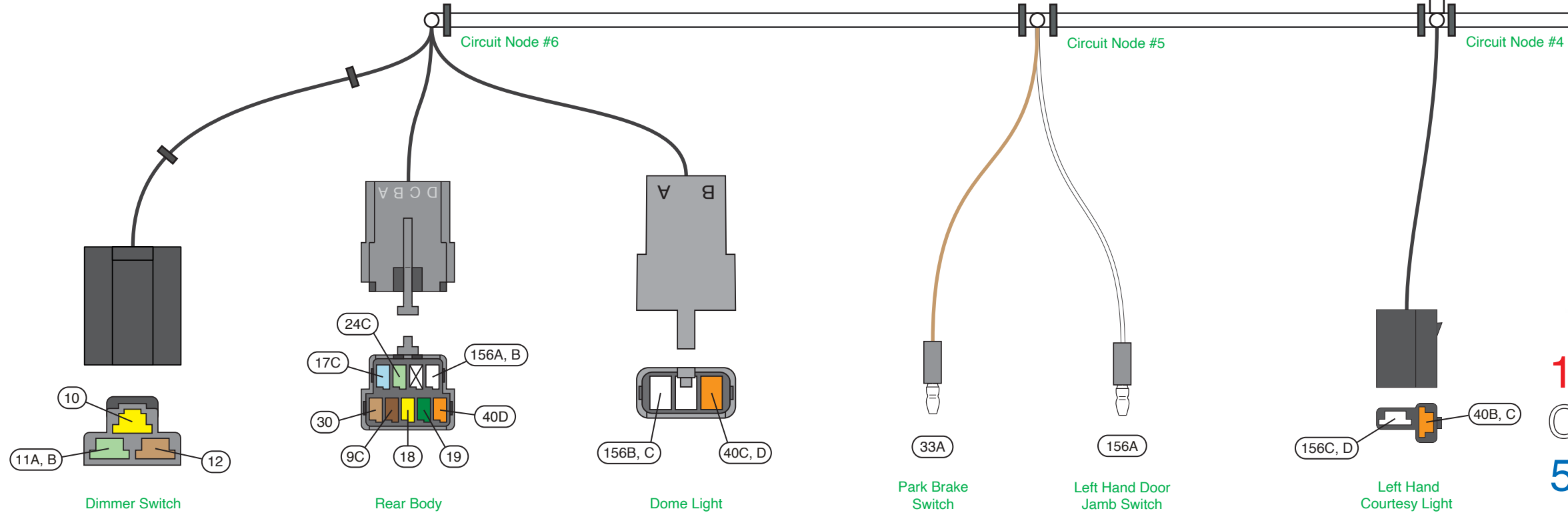

1968-70 Mopar B-Body
Classic Update Series
510888

© COPYRIGHT 2004 American Autowire / Factory-Fit
Used with express permission of
American Autowire / Factory-Fit
92973525 Rev 1.0 6/22/2023

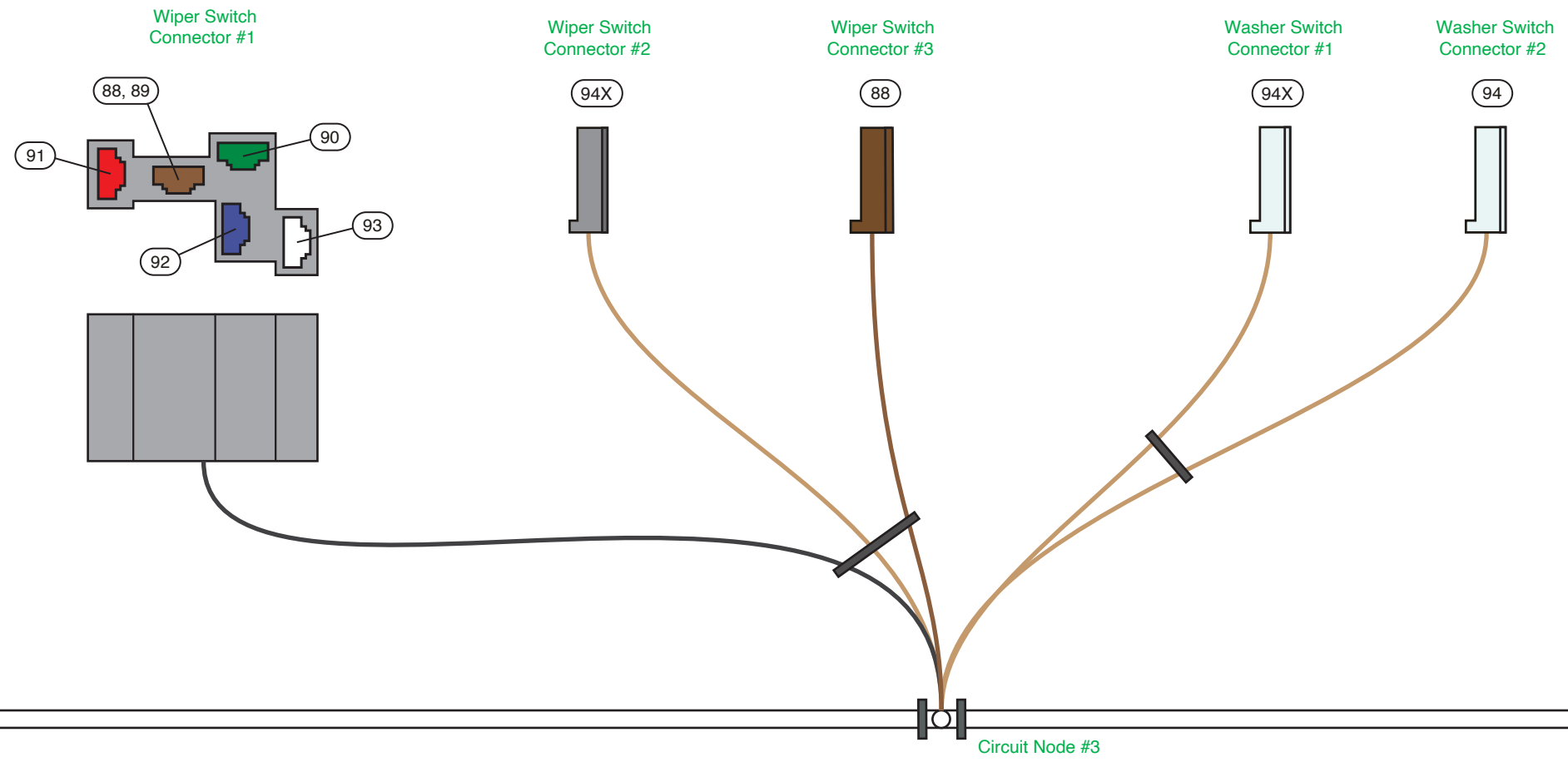

Wiring-side of Bulkhead Connector, is shown.

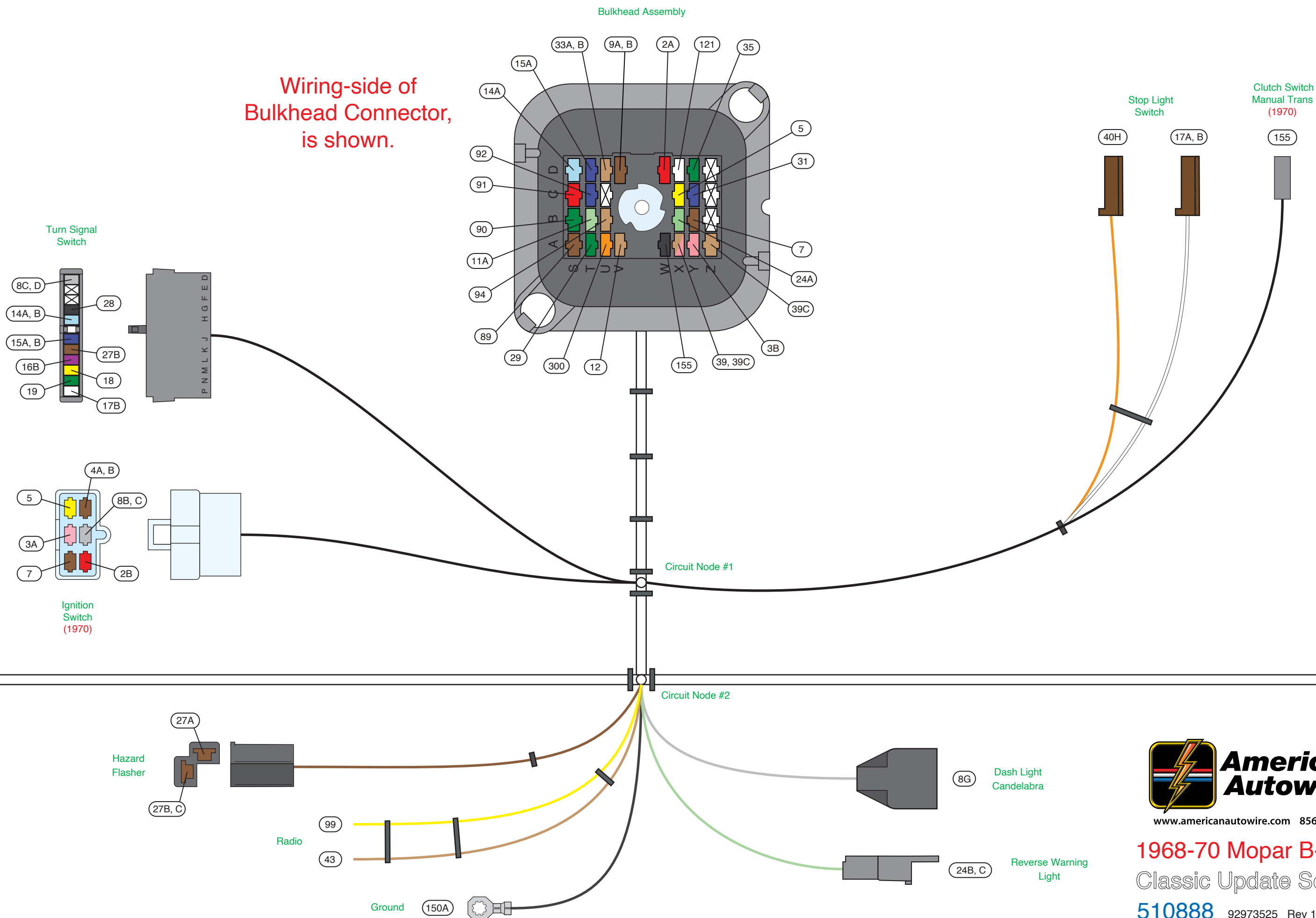

American Autowire
www.americanautowire.com 856-933-0801
1968-70 Mopar B-Body
Classic Update Series
510888 92973525 Rev 1.0 6/22/2023

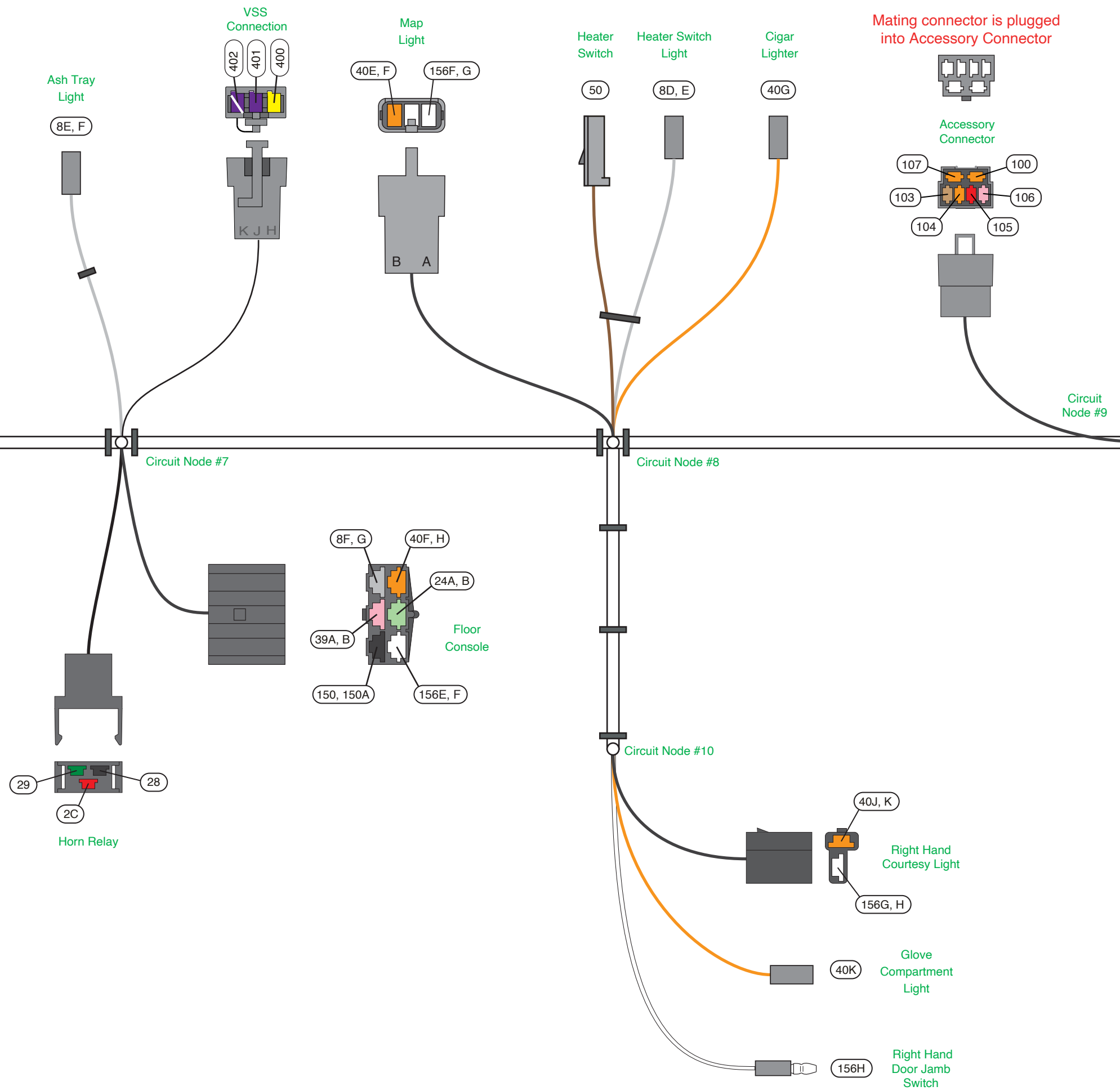

Mating connector is plugged into Accessory Connector

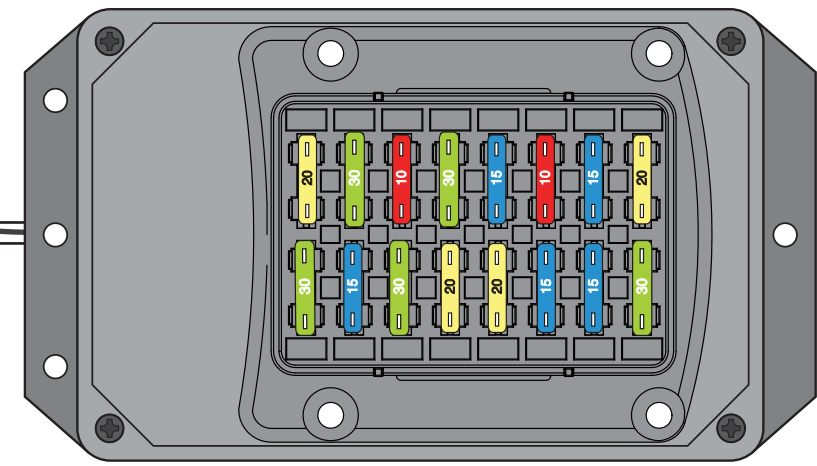
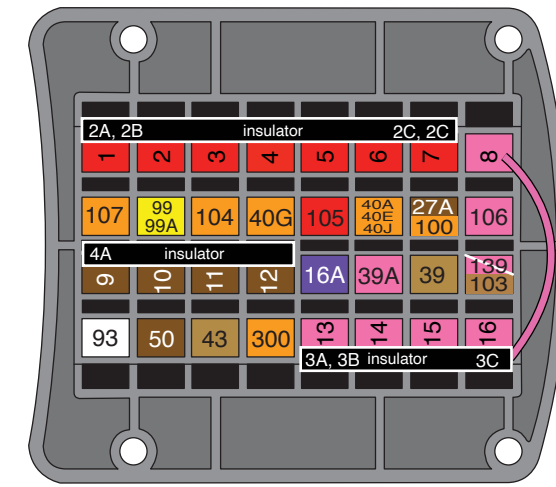

1	9	Wiper	20A - ACC
2	10	Heat/AC	30A - ACC
3	11	Radio	10A - ACC
4	12	Engine Fan	30A - ACC
5	13	Turn	15A - IGN
6	14	Gauges, B/U	10A - IGN
7	15	Hazard	15A - IGN
8	16	Fuel Pump	20A - IGN
Batt - Spare	30A - BAT		
Clock/Radio	15A - BAT		
Power Seat	30A - BAT		
Cigar - Lighter	20A - BAT		
Power Locks	20A - BAT		
Stop/Courtesy	15A - BAT		
Hazard	15A - BAT		
Pwr. Window	30A - IGN		

Fuse label on inside of Fuse Box lid



1968-70 Mopar B-Body
Classic Update Series

Legend:

Bag
G

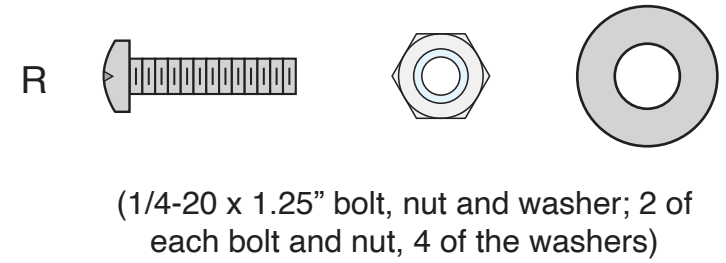
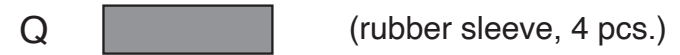
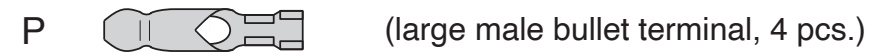
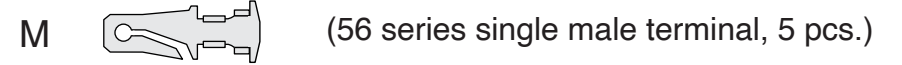
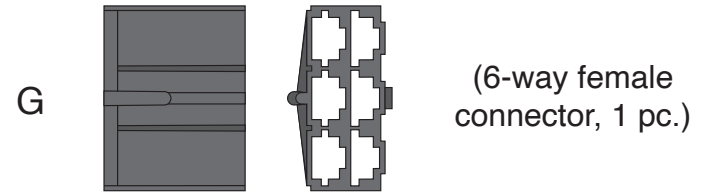
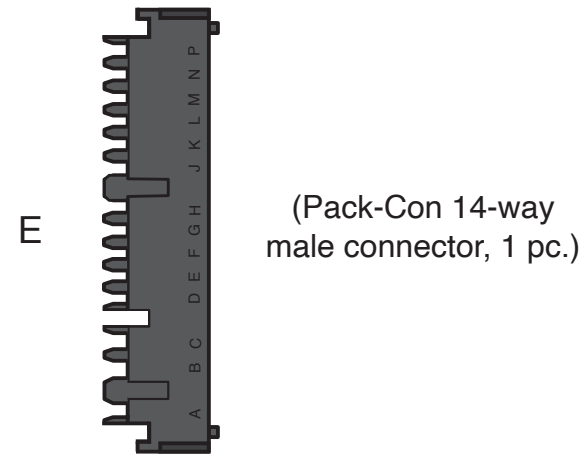
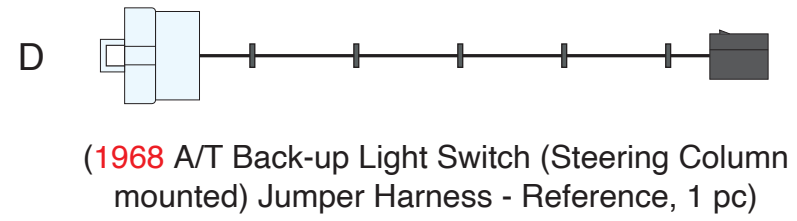
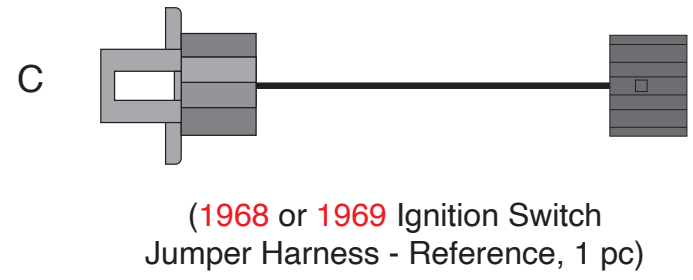
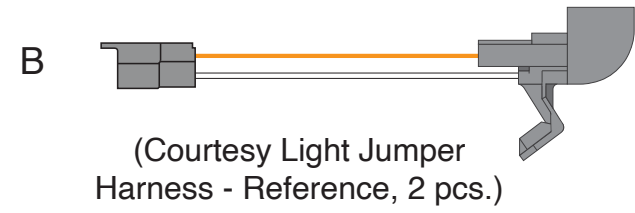
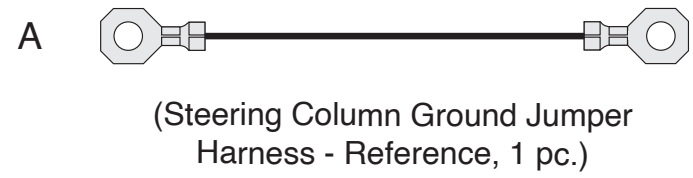

1968-70 Mopar B-Body
Classic Update Series
510888 92973525 Rev 1.0 6/22/2023

Note: Prior to installing the Dash Harness, obtain the Fuse, Flasher, and Relay Kit #510557 (located in Bag G) and plug all of the Fuses in the Fuse Block (See page 4 for the location of the fuses). Install the Horn Relay (see Circuit Node #7) and the two Flashers to the Dash Harness (see Circuit Nodes #2 and #4).

Steering Column Ground

Obtain the Steering Column Ground Jumper Harness "A" from the Dash Harness Kit Bag G. See the Legend on page 5 for an illustration of the Jumpers and the wiring components. This 1-wire jumper will replace the existing original ground jumper and will use the same fasteners. Attach the Steering Column Ground Jumper Harness "A" to the Steering Column and to the lower Dash.

Dash Harness Routing

The Dash Harness routing will be the same as the original factory Instrument Panel Wiring Harness routing. Be sure to duplicate this routing. The new Dash Harness is in the shape of a T. One segment of the trunk of the T will route to the right towards the Glove Box, one segment of the trunk will route to the left towards the Cluster, and the last segment of the trunk will route towards the Firewall. Now proceed to the individual Circuit Node Instructions below.

Circuit Node #1

Bulkhead Assembly Attachment

Locate the original factory Bulkhead Connector rectangular hole in the left center of the Firewall. The new Bulkhead Assembly will mount in this same Firewall hole (see photo #1). When the Bulkhead Connector is attached to the Firewall, the wires of the Dash Harness, inside the car, will initially route downward. Two pass-through holes will be required for the 1/4 - 20 x 1.25 machine screws. See the Bulkhead Attachment Instructions 92971552 for mounting the Bulkhead Assembly. Use 2 Screws, 4 Washers, and 2 Locking Nuts (items "R" from Loose Parts Kit 92972817) to attach the Bulkhead Assembly to the Firewall. **NOTE: A Washer will be under the head of each Machine Screw and another Washer will be under each Locking Nut.**

Attach the Main Trunk of the Dash Harness adjacent to the center lower clip of the Instrument Panel similar to the original wiring (see Photo #2).

Turn Signal Switch Preparation **NOTE:** For all of the vehicles, the Turn Signal Switch is mounted to the Steering Column. You will continue to use this original Turn Signal Switch, but will have to remove the original connector from the pigtail and replace this connector with the black 14-way connector "E" and terminals "F" (located in Parts Kit 92972817 in Bag G). See Diagram 'A' and Diagram 'B' plus "Table B" on page 12 for details.

Turn Signal Switch Connector Once you have modified the original Turn Signal Switch Pigtail by adding the black 14-way male connector "E", obtain the 11-way Turn Signal Switch connector, which is part of the Dash Harness, and plug it into the 14-way connector "E" of the Turn Signal Switch.

Wire #	Wire Color	Printing	Description
8C, D	Gray	DASH LIGHTS	Steering Column PRNDL Light Illumination feed for the 1968-69 vehicles.
14A, B	Light Blue	LEFT FRONT TURN	Left Front Turn Signal feed.
15A, B	Dark Blue	RIGHT FRONT TURN	Right Front Turn Signal feed.
16B	Purple	TURN SWITCH FEED	Turn Signal Switch feed from the Turn Signal Flasher.
17B	White	BRAKE SW	Brake Switch feed to the Turn Signal Switch.
18	Yellow	LEFT REAR TURN	Feed to the Left Rear Turn Signal Light.
19	Dark Green	RIGHT REAR TURN	Feed to the Right Rear Turn Signal Light.
27B	Brown	TURN SW - HAZARD	Feed from the Hazard Flasher.
28	Black	HORN RELAY	Ground from the Horn Relay to the Horn Switch.

Ignition Switch (1968-69) **NOTE:** For the 1968-69 vehicles, the Ignition Switch is located on the IP. You will obtain the Ignition Switch Jumper Harness "C" from Bag G and plug the black 6-way connector into the white 6-way Ignition Switch Connector on the Dash Harness and then connect the Ignition Switch connector to the Ignition Switch.

Ignition Switch Jumper Harness (1968-69) This is the Jumper Harness "C" that will plug into the 6-way white connector on the Dash Harness and the 1968-69 Ignition Switch.

Wire #	Wire Color	Printing	Description
2X	Red	12V BATTERY	12V Battery feed.
3X	Pink	IGNITION FEED	12V Ignition feed.
4X	Brown	IGNITION SW ACCY	12V Ignition Accessory feed.
5X	Yellow	no printing	Start circuit.
7X	Brown	no printing	Ignition feed during crank to the Ignition Coil.



Ignition Switch (1970) Pigtail Preparation **NOTE:** For the 1970 vehicles, the Ignition Switch is mounted to the Steering Column. You will continue to use this original Ignition Switch, but will have to remove the original connector from the pigtail and replace the connector with the black 6-way connector "G" and terminals "H" and "J" (from Parts Kit 92972817 in Bag G). See "Table A" on page 13 for details. For vehicles with an aftermarket GM-style steering column mounted switch, adapter 510941 will need to be purchased. See "Table B" on page 13 for details. **Note:** the additional two thin red wires in the Ignition Switch pigtail are for the Key-in Ignition Warning Buzzer and will not be used.

Ignition Switch Connector (1970 Vehicles) Once you have modified the original Ignition Switch Pigtail by adding the black 6-way connector "G", obtain the white 6-way Ignition Switch connector, which is part of the Dash Harness, and plug it into the black 6-way connector "G" of the Ignition Switch.

Wire #	Wire Color	Printing	Description
2B	Red	12V BATTERY	12V Battery feed.
3A	Pink	IGNITION FEED	12V Ignition feed from the Ignition Switch.
4A	Brown	IGNITION SW ACCY	12V Accessory feed from the Ignition Switch.
4B	Brown	no printing	12V Accessory feed to the Cluster.
5	Yellow	no printing	Start circuit.
7	Brown	no printing	Ignition feed during crank to the Ignition Coil.
8B, C	Gray	DASH LIGHTS	Illumination Light feed wires to the PRNDL Light on the Steering Column (if so equipped).

Stop Light Switch Connectors Connect these two 1-way brown connectors to the Brake Switch; polarity doesn't matter.

Wire #	Wire Color	Printing	Description
17A, B	White	BRAKE SW	Brake Switch feed to the Turn Signal Switch.
40H	Orange	BRAKE SW	12V Battery Fused feed from the Fuse Block.

Clutch Switch (1970 with Manual Transmission). **NOTE:** For the 1970 vehicles equipped with a Manual Transmission, when the Clutch Pedal is depressed, the Clutch Switch will provide a ground path for the ground "G" terminal of the Starter Relay through wire 155. This will allow the Engine to crank when the Ignition Switch is rotated to the Start position. For the 1968-69 vehicles, this Clutch Switch Connector can be taped back.

Clutch Switch Connector (1970) Connect the 1-way female bullet Clutch Switch connector to the Clutch Interlock Switch pigtail.

Wire #	Wire Color	Printing	Description
155	Black	no printing	Ground wire from the Starter Relay to the Clutch Switch.

Bag
G

Bulkhead Assembly

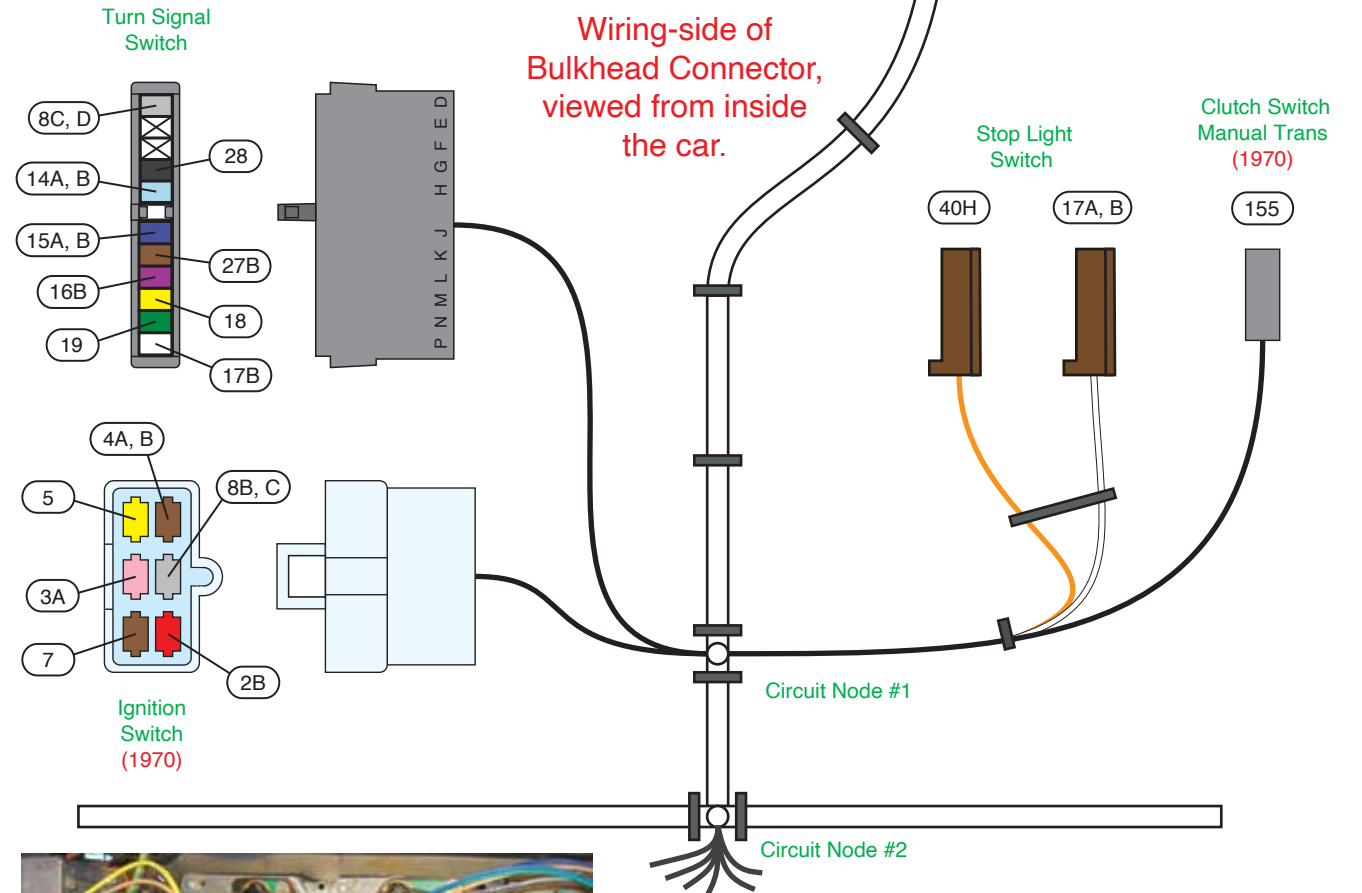
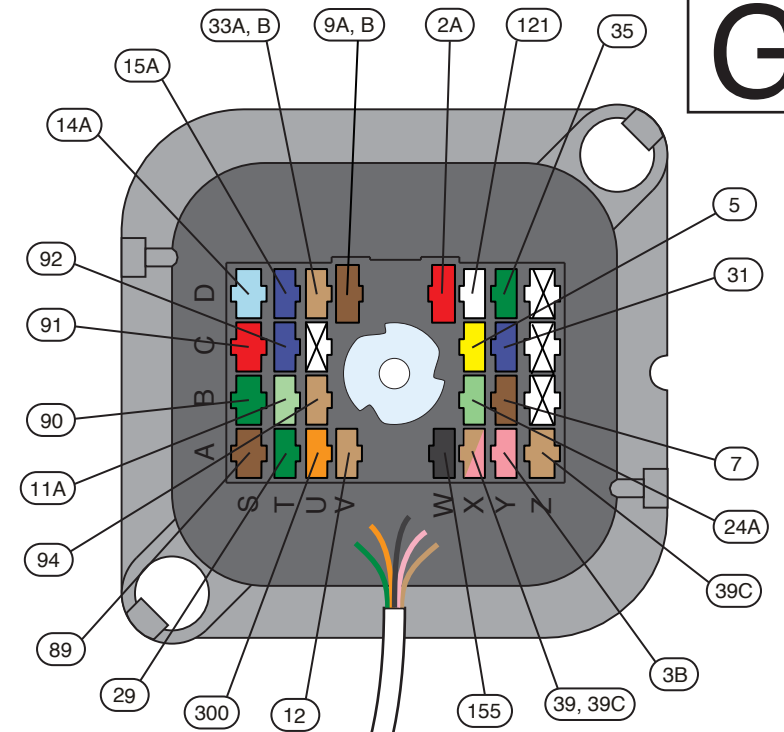

Circuit Node #2, at the center lower clip of the Instrument Panel

Photo #2



1968-70 Mopar B-Body
Classic Update Series
510888 92973525 Rev 1.0 6/22/2023

Circuit Node #2

Hazard Flasher Connector If you haven't already; plug one of the Flashers (included in kit #510557 in Bag G) into this connector. Attach the Flasher to the original metal Flasher Retainer on the IP, if so equipped.

Wire #	Wire Color	Printing	Description
27A	Brown	TURN SW-HAZARD	12V Battery feed to the Hazard Flasher.
27B, C	Brown	TURN SW-HAZARD	12V feed from the Hazard Flasher.

Radio Wires These wires are provided for your Radio.

Wire #	Wire Color	Printing	Description
43	Tan	RADIO	12V Fused Accessory Feed to the Radio for "On/Off" power.
99	Yellow	RADIO BAT	12V Fused Battery Feed for the Radio Memory.

Ground **Note: Be sure to attach this ground ring terminal to a good vehicle ground. If not attached to ground, your Cluster Lights may not be functional. Note: Do not attach this ring terminal under the same screw as the 151 circuit ground wire from Node #4.**

Wire #	Wire Color	Printing	Description
150A	Black	GROUND	Ground wire.

Reverse Warning Light Connector (4-spd Manual Transmission Vehicles only) This connector provides a feed to the Reverse Gear Warning Light that is mounted on the lower Dash for Manual Transmission vehicles. Plug the pigtail of your original Reverse Light into this connector.

Wire #	Wire Color	Printing	Description
24B, C	Light Green	BACK UP LT SW --> LIGHTS	Feed from the Back-up Light Switch.

Dash Light Candelabra This 3-way female bullet connector provides a connection point for any Illumination Light feed that may be required, such as to the Radio, an Aftermarket Tachometer, the Ignition Switch Illumination Light, etc. This is the same circuit as the Instrument Cluster Illumination Lights and will dim when the Panel Dimmer Switch Knob is rotated. Extra wire length of the gray "DASH LIGHTS" wire (circuit 8) is available in the Cluster Kit 510636 in Bag H. Also, male bullet terminals "P" and sleeves "Q" (to plug into the Candelabra Connector) are available in the Dash Harness Parts Kit 92972817 in Bag G for this application.

Wire #	Wire Color	Printing	Description
8G	Gray	DASH LIGHTS	Dash Lights feed wire.

Circuit Node #3

Wiper Switch Connector #1 Plug this 5-way connector to the Wiper Switch.

Wire #	Wire Color	Printing	Description
88	Brown/White	no printing	This is a resistance wire which is part of the 3-speed Wiper System circuitry.
89	Brown	no printing	Armature feed from the Wiper Switch to the Wiper Motor.
90	Dark Green	no printing	Motor Field #1 feed from the Wiper Switch to the Wiper Motor.
91	Red	no printing	Motor Field #2 feed from the Wiper Switch to the Wiper Motor.
92	Dark Blue	no printing	Park feed from the Wiper Switch to the Wiper Motor.
93	White	WIPER FEED	Fused 12V Accessory feed from the Fuse Block to the Wiper Switch.

Wiper Switch Connector #2 This is the 1-way black connector with a notch on the side. Plug this black connector to the Wiper Switch terminal B/U with the nib on the side.

Wire #	Wire Color	Printing	Description
94X	Tan	no printing	12V feed from the Wiper Switch to the Washer Switch for the Washer Pump.

Wiper Switch Connector #3 Plug this brown 1-way connector to the 3-speed Wiper Switch terminal "R". This wire is only used with the 3-speed Wiper System.

Wire #	Wire Color	Printing	Description
88	Brown/White	no printing	This is a resistance wire which is part of the 3-speed Wiper System circuitry.

Washer Switch Connector #1 Plug this 1-way white connector to either one of the Washer Switch terminals. This is the 12V feed to the Washer Switch.

Wire #	Wire Color	Printing	Description
94X	Tan	no printing	12V feed from the Wiper Switch to the Washer Switch for the Washer Pump.

Washer Switch Connector #2 Plug this 1-way white connector to the second Washer Switch terminal.

Wire #	Wire Color	Printing	Description
94	Tan	no printing	12V feed from Washer Switch to the Electric Washer Pump Motor.

Bag
G

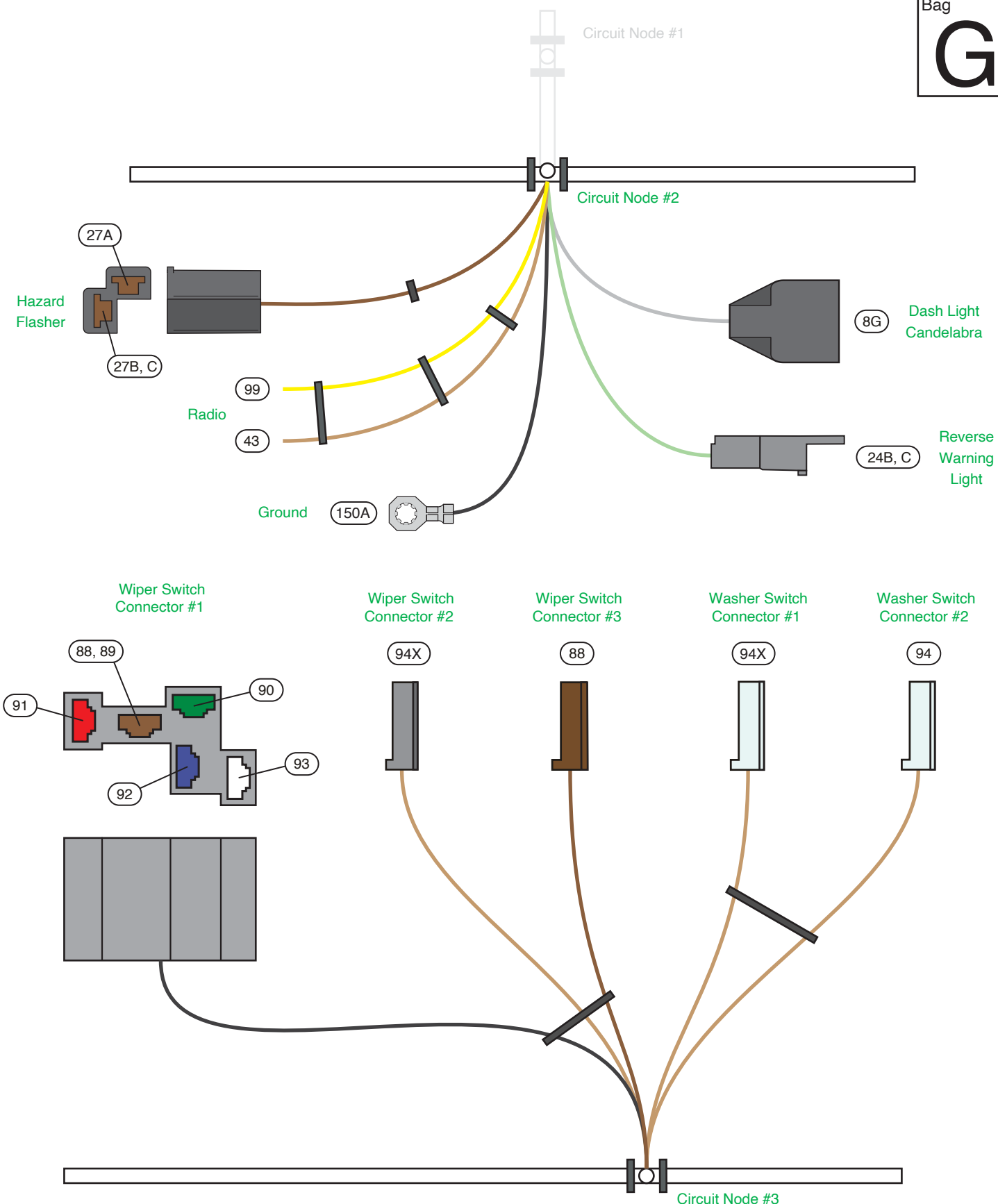

www.americanautowire.com

1968-70 Mopar B-Body
Classic Update Series

510888 92973525 Rev 1.0 6/22/2023

Circuit Node #4

Aftermarket Electric Speedo Ground **Note: Do not attach this ring terminal with any other ground ring terminal; it must be grounded all by itself to a good vehicle ground.**

Wire #	Wire Color	Printing	Description
151	Black/White	SPEEDO GROUND	Ground for an Aftermarket Electric Speedometer.

Turn Flasher Connector If you haven't already; plug one of the Flashers (included in kit #510557 in Bag G) into this connector. Attach the Flasher to the original metal Flasher Retainer on the Dash, if so equipped.

Wire #	Wire Color	Printing	Description
16A	Purple	TURN SWITCH FEED	12V Ignition feed from the Fuse Block.
16B	Purple	TURN SWITCH FEED	12V feed from the Turn Flasher to the Turn Signal Switch.

Instrument Cluster Connections These connectors will plug to the connectors of the Gauge Cluster Kit 510785 in Bag H.

Cluster Connector "A"

Wire #	Wire Color	Printing	Description
4B	Brown	no printing	12V Ignition Accessory feed.
8A, B	Gray	DASH LIGHTS	Illumination Light feed for the Cluster Illumination Lights.
39B	Pink	12V IGNITION	12V Fused Ignition feed.
99A	Yellow	CLOCK BAT	12V Battery feed to the Clock.
150	Black	GROUND	Cluster ground.

Cluster Connector "B"

Wire #	Wire Color	Printing	Description
11B	Light Green	HI BEAM INDICATOR LIGH	Feed to the High Beam Indicator Light.
14C	Light Blue	LEFT DASH IND	Feed for the Left Turn Signal Indicator Light.
15C	Dark Blue	RIGHT DASH IND	Feed for the Right Turn Signal Indicator Light.
30	Tan	GAS GAUGE	Fuel Gauge Signal from the Fuel Tank Sending Unit.
31	Dark Blue	OIL PRESSURE SENDER	Oil Pressure Sender Signal from the Engine.
33B	Tan	BRAKE LIGHT/SWITCH	Brake Warning Light Signal to ground.
35	Dark Green	WATER TEMP SENDER	Water Temperature Sender Signal from the Engine.
121	White	COIL --> TACH	Tachometer feed to the Ignition Coil.

Cluster Connector "C" This connector contains the wires for an Aftermarket Electric Speedometer. **NOTE: Wires "400" and "401" must remain twisted together.**

Wire #	Wire Color	Printing	Description
139	Pink/White	SPEEDO POWER	Fused 12V Ignition feed for the Electric Speedometer.
151	Black/White	SPEEDO GROUND	Electric Speedometer Ground.
400	Yellow	VSS GROUND	Vehicle Speed Sensor Ground.
401	Purple	VSS SIGNAL	Vehicle Speed Sensor Signal.
402	Purple/White	VSS POWER	Vehicle Speed Sensor Power.

Panel Dimmer Switch This 3-way connector will plug to your Instrument Panel Light Dimmer Switch.

Wire #	Wire Color	Printing	Description
8A	Gray	DASH LIGHTS	Illumination Light feed from the Panel Dimmer Switch to the Dash Lights.
9B	Brown	PARK LIGHTS	Park Lights/Rear Running Lights feed to the Panel Dimmer Switch.
9C	Brown	REAR RUNNING LIGHTS	Park Lights/Running Lights feed to the Panel Dimmer Switch.
156D, E	White	CTSY GROUND	Dome and Courtesy Lights switched ground.

Headlight Switch Connector Plug this 5-way connector onto the Headlight Switch.

Wire #	Wire Color	Printing	Description
2D	Red	12V BATTERY	12V Battery feed to the Headlight Switch for the Headlights.
9A	Brown	PARK LIGHTS	Feed to the Front Park Lights and the Rear Running Lights.
10	Yellow	DIMMER SW FEED	Feed to the Headlight Dimmer Switch.
40A, B	Orange	12V BATTERY-FUSED	12V Fused Battery feed to the Headlight Switch for the Park Lights, the Courtesy Lights, the Dome Light, and the Trunk Light.

Emergency Flasher Switch (1968-69) **NOTE: This standalone Emergency Flasher Switch is only available on the 1968-69 vehicles. For 1970, this switch is integral with the Steering Column and this 4-way connector will not be used and can be taped back.**

Emergency Flasher Switch Connector (1968-69) Plug the 4-way Emergency Flasher Switch Connector to your Emergency Flasher Switch.

Wire #	Wire Color	Printing	Description
14B, C	Light Blue	LEFT FRONT TURN	Feed to the LH Turn Signal Light and to the Turn Signal Switch.
15B, C	Dark Blue	RIGHT FRONT TURN	Feed to the RH Turn Signal Light and to the Turn Signal Switch
17A	White	BRAKE SW	Feed from the Stop Light Switch.
17C	Light Blue	THIRD BRAKE LIGHT	Feed to the Third Brake Light.
27C	Brown	TURN SW - HAZARD	Feed from the Hazard Flasher.

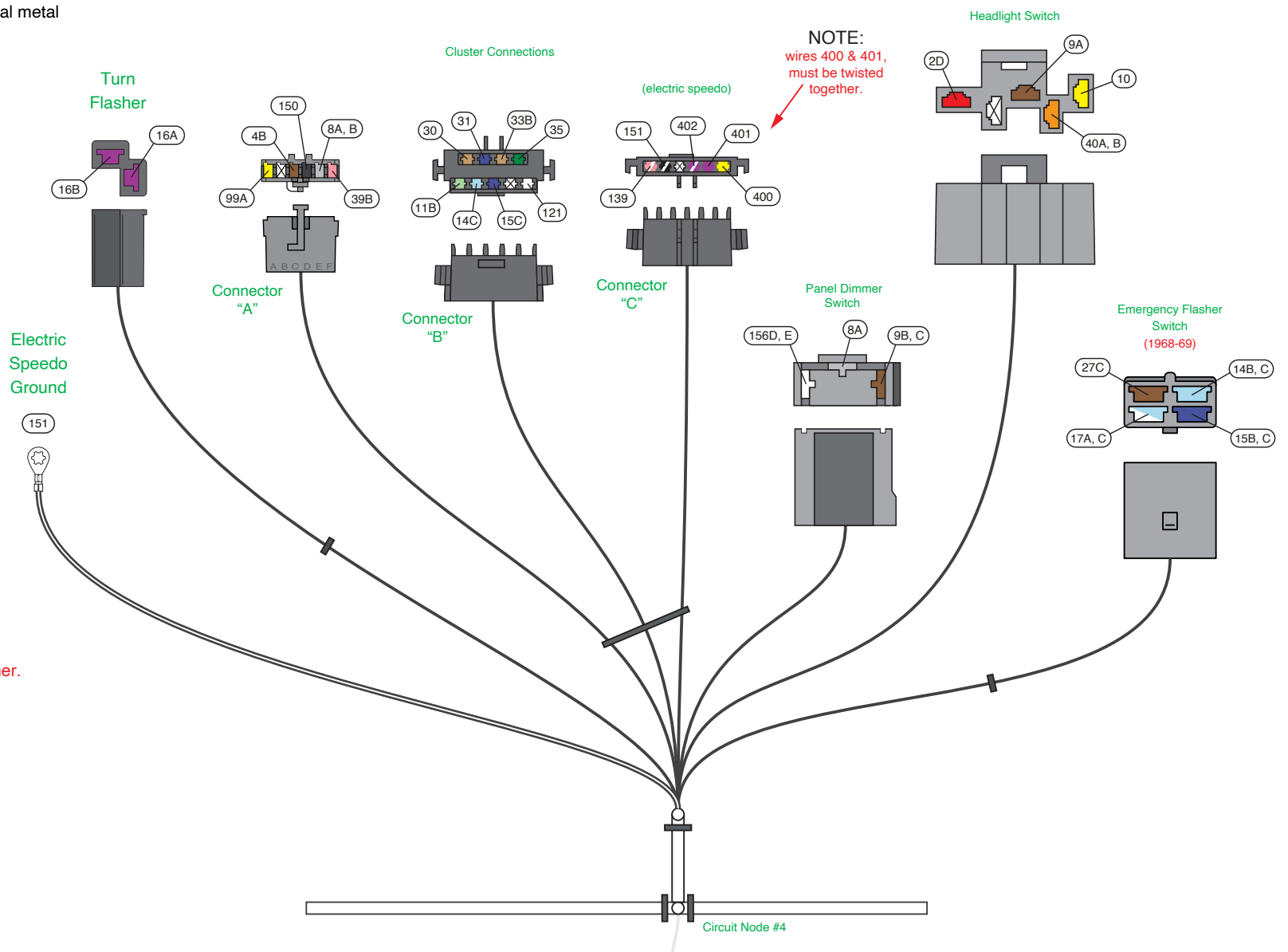

1968-70 Mopar B-Body
Classic Update Series
510888 92973525 Rev 1.0 6/22/2023

Circuit Node #4 (continued)

Left Hand Courtesy Light Plug the 2-way Left Hand Courtesy Light Connector, which is part of the Dash Harness, into one of the Courtesy Light Jumper Harnesses "B" in Bag G. Attach the Courtesy Light Jumper Harness "B" to the LH lower Outboard IP. **NOTE: This Courtesy Light utilizes a #631 Bulb (which is not included in this kit).**

Wire #	Wire Color	Printing	Description
40B, C	Orange	12V BATTERY – FUSED	12V Battery feed to the LH Courtesy Light.
156C, D	White	CTSY GROUND	Switched ground for the LH Courtesy Light.

Circuit Node #5

Park Brake Switch Connector Plug this male bullet Park Brake Switch connector onto your Park Brake Switch.

Wire #	Wire Color	Printing	Description
33A	Tan	BRAKE LIGHT/SWITCH	Wire from the Brake Warning Light to the Park Brake Switch.

Left Hand Door Jamb Switch Connector Route the Left Hand Door Jamb Switch Connector into the Side Cowl and through the Door Jamb Switch Hole and connect to the Door Jamb Switch. **Note: the Door Jamb Switch 500100 is available for purchase from AAW.** This self tapping Door Jamb Switch will fit into a 3/8"-24 hole. Some 1970 vehicles have a larger hole and this switch will not fit.

Wire #	Wire Color	Printing	Description
156A	White	CTSY GROUND	LH Switched Ground for the Courtesy/ Dome Lights.

Circuit Node #6

Dimmer Switch Connector This wiring branch will route to the Dimmer Switch 500042 (located in Bag G). Attach the 3-way Dimmer Switch connector to the Dimmer Switch and attach to the Floor Pan in the original location.

Wire #	Wire Color	Printing	Description
10	Yellow	DIMMER SW FEED	Feed from the Headlight Switch.
11A	Light Green	HEADLIGHT-HI BEAM	Feed to the High Beam Headlights.
11B	Light Green	HI BEAM INDICATOR	Feed to the High Beam Indicator Light in the Instrument Cluster.
12	Tan	HEADLIGHT-LOW BEAM	Feed to the Low Beam Headlights.

Rear Body Connector This 9-way connector will plug into the 9-way connector of the Rear Body Harness Kit 510639 in Bag M.

Wire #	Wire Color	Printing	Description
9C	Brown	REAR RUNNING LIGHTS	Feed for the Tail Lights, the License Light, the Rear Running Lights, and the Rear Side Marker Lights.
17C	Light Blue	THIRD BRAKE LIGHT	Feed for an aftermarket Third Brake Light.
18	Yellow	LEFT REAR TURN	Feed to the Left Rear Stop and Turn Lights.
19	Dark Green	RIGHT REAR TURN	Feed to the Right Rear Stop and Turn Lights.
24C	Light Green	BACK UP LT SW --> LIGHTS	Feed from the Back-up Light Switch to the Back-up Lights.
30	Tan	GAS GAUGE	Fuel Tank Sender.
40D	Orange	12V BATTERY-FUSED	12V Battery feed to the Trunk Light.
156A, B	White	CTSY GROUND	Switched Ground for the Dome/Courtesy Lights.

Dome Light Connector This 2-way connector will connect to the Dome Light Jumper Harness which is included in the Rear Body Harness Kit 510639 in Bag M.

Wire #	Wire Color	Printing	Description
40C, D	Orange	12V BATTERY-FUSED	Feed to the Dome Light.
156B, C	White	CTSY GROUND	Switched Ground for the Dome/Courtesy Lights.

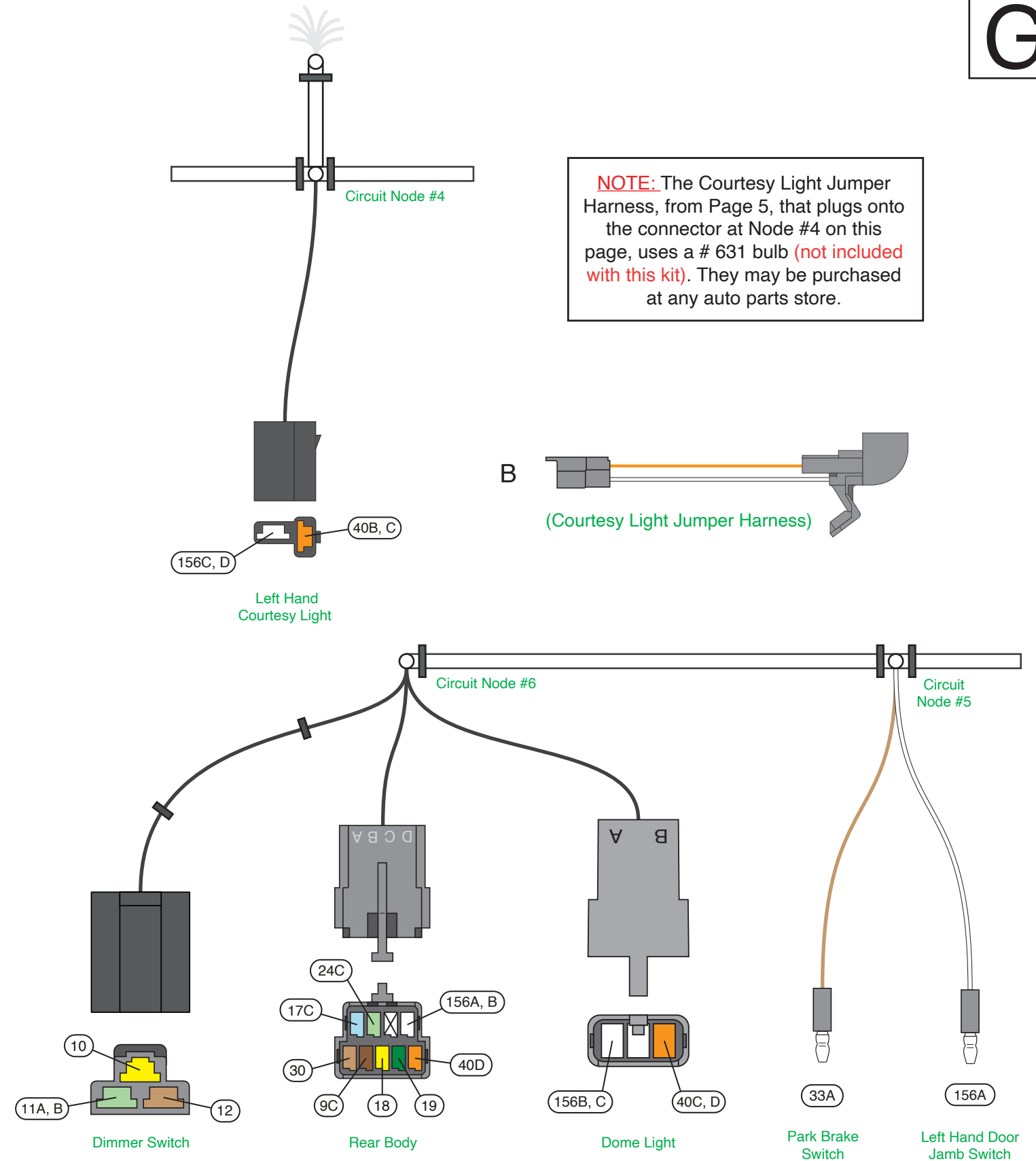

Circuit Node #7

Ash Tray Light Connector Connect the Ash Tray Light female bullet connector to the Ash Tray Light pigtail.

Wire #	Wire Color	Printing	Description
8E, F	Gray	DASH LIGHTS	Dash Light feed to the Ash Tray Light pigtail.

Horn Relay Connector If you haven't already; plug the Horn Relay (included in kit #510557 in Bag G) into this connector.

Wire #	Wire Color	Printing	Description
2C	Red	12V BATTERY	12V Battery feed to the Horn Relay.
28	Black	HORN RELAY GROUND	Relay ground circuit to the Steering Column Horn Switch.
29	Dark Green	HORN	Feed to the Horns.

Floor Console Connector This connector is provided if you have a **Floor Console** option or a **1968** vehicle with the Back-up Light Switch on the Steering Column.

Wire #	Wire Color	Printing	Description
8F, G	Gray	DASH LIGHTS	Dash Light feed to the Floor Console PRNDL Light.
24A, B	Light Green	BACK UP LT SW --> LIGHTS	Feed from the Floor Console Back-up Light Switch to the Back-up Lights.
39A, B	Pink	12V IGNITION	Fused 12V Ignition feed to the Floor Console Back-up Light Switch.
40F, H	Orange	12V BATTERY-FUSED	Fused 12V Battery feed to the Floor Console Courtesy Lights.
150, 150A	Black	GROUND	Ground for the Floor Console PRNDL Light.
156E, F	White	CTSY GROUND	Switched ground for the Floor Console Courtesy Lights.

VSS Connection These wires and connector are for use with an aftermarket electric speedometer only. The VSS Lead Wires, 510730, bag V, will plug in here. Refer to that instruction sheet for wire functions and additional directions

Floor Console Wiring Kit If you have a Floor Console obtain the Floor Console Wiring Kit 510640 in Bag G and plug it into the 6-way Floor Console Connector. Route the Floor Console Harness under the carpet and alongside the Floor Console. Tuck the harness under the carpet and make the connections to the Floor Console components from the rear of the Floor Console. See the Floor Console Kit Instructions for additional details. The Floor Console Wiring Harness will connect to the Courtesy Lights, the Automatic Transmission PRNDL Illumination Light, and the Back-up Light Switch (1968).

1968 Automatic Transmission Back-up Light Switch Jumper Harness If you have a 1968 car with the Automatic Transmission Shifter on the Steering Column, you will need to plug the 1968 A/T Back-up Light Switch (Steering Column mounted) Jumper Harness "D" in Bag G to the Floor Console Connector and plug the other end of the Jumper to the Back-up Light Switch on the Steering Column. The 2-way mating connector "L" and terminals "M" have been provided (in Loose Piece Kit 92972817) to crimp on to the Back-up Light Switch Pigtail.

Circuit Node #8

Cigar Lighter Connector Connect the Cigar Lighter female bullet connector to the Cigar Lighter.

Wire #	Wire Color	Printing	Description
40G	Orange	12V BATTERY-FUSED	Fused 12V Battery feed to the Cigar Lighter.

Heater Switch Illumination Light Connector This female bullet connector will plug into the orange wire pigtail from the Heater Control Assembly Illumination Light.

Wire #	Wire Color	Printing	Description
8D, E	Gray	DASH LIGHTS	Illumination Light feed wire for the Heater Control Assembly Light.

Heater Switch Connector This 1-way connector will plug into the 1-way connector with the black wire from the Heater Control Assembly. Connector "K" and terminal "M" are provided if you need to replace the original connector on your Heater Control Assembly pigtail. See figure "A" above for details.

Wire #	Wire Color	Printing	Description
50	Brown	HEATER/AC FEED	12V feed from the Fuse Block.

Heater Blower Motor Resistor **Note: the pigtail with the 3-way connector from the original Heater Switch Control Assembly will plug into the Heater Blower Motor Resistor. There are no wires provided in this kit for the Heater Blower Motor Resistor connection. See figure "A" above.**

Map Light Connector This 2-way connector will plug into the optional Map Light. **Note: the Map Light Wiring Kit 510430 is available for purchase from American Autowire.**

Wire #	Wire Color	Printing	Description
40E, F	Orange	12V BATTERY-FUSED	Fused 12V Battery feed to the Map Light.
156F, G	White	CTSY GROUND	Switched ground for the Map Light.

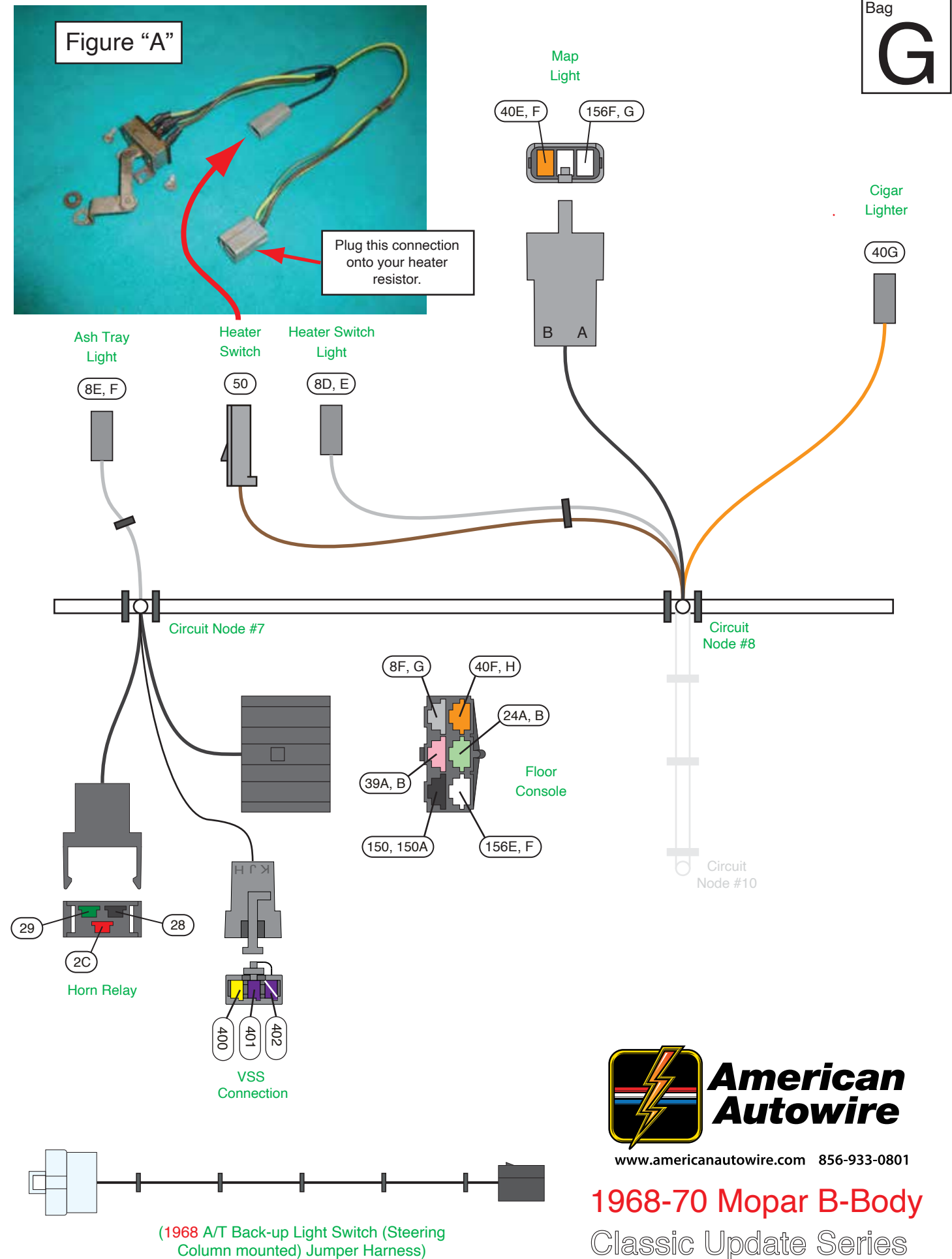

www.americanautowire.com 856-933-0801

1968-70 Mopar B-Body
Classic Update Series

510888 92973525 Rev 1.0 6/22/2023

Circuit Node #9

Fuse Block Attachment The Fuse Block will be located in the Glove Box. Provide a clearance opening at the left end of the Glove Box Liner and slide the Fuse Block into the Glove Box. Attach the Fuse Block to the floor of the Glove Box with three screw, nut and washers "N" (see Photos #3 and #4).

Accessory Connector Use the provided 6-way empty connector, which is attached to the 6-way Accessory connector on the Dash Harness, and terminals "H" and "J" (included in Parts Kit 92972817 in Bag G) to add power wires (not provided) for the following optional systems:

1968-70 B-Body Accessory Connector

Wire #	Wire Color	Printing	Fuse #	Fuse Block Cover	Fuse rating	Description
100	Orange	(no printing)	7	Hazard	15A	Battery feed for Hazard or Audio Systems.
103	Tan	FUEL PUMP	16	Fuel Pump	20A	Ignition feed for an Electric Fuel Pump.
104	Orange	POWER SEATS	3	Pwr Seats	30A	Battery feed for Power Seats.
105	Red	POWER LOCKS	5	Pwr Locks	20A	Battery feed for Power Locks.
106	Pink	POWER WINDOWS	8	Pwr Window	30A	Accessory feed for Power Windows.
107	Orange	12V BATTERY FUSED	1	Bat-Spare	30A	Battery feed for options.

Circuit Node #10

Right Hand Courtesy Light Plug the 2-way Right Hand Courtesy Light Connector, which is part of the Dash Harness, into one of the Courtesy Light Jumper Harnesses "B" in Bag G. Attach the Courtesy Light Jumper Harness "B" to the RH Lower Outboard IP. **NOTE: This Courtesy Light utilizes a #631 Bulb (which is not included in this kit).**

Wire #	Wire Color	Printing	Description
40J, K	Orange	12V BATTERY – FUSED	12V Battery feed to the RH Courtesy Light.
156G, H	White	CTSY GROUND	Switched ground for the RH Courtesy Light.

Glove Compartment Light Connector Plug the female bullet Glove Compartment Light connector to the Glove Compartment Switch/Light Pigtail.

Wire #	Wire Color	Printing	Description
40K	Orange	12V BATTERY – FUSED	12V Battery feed to the Glove Compartment Light.

Right Hand Door Jamb Switch Connector Route the Right Hand Door Jamb Switch Connector into the Side Cowl and through the Door Jamb Switch Hole and connect to the Door Jamb Switch **Note: the Door Jamb Switch 500100 is available for purchase from AAW.** This self tapping Door Jamb Switch will fit into a 3/8"-24 hole. Some 1970 vehicles have a larger hole and this switch will not fit.

Wire #	Wire Color	Printing	Description
156H	White	CTSY GROUND	RH Switched Ground for the Courtesy/ Dome Lights.

NOTE: The Courtesy Light Jumper Harness, from Page 5, that plugs onto the connector at Node #10 on this page, uses a # 631 bulb (not included with this kit). They may be purchased at any auto parts store.

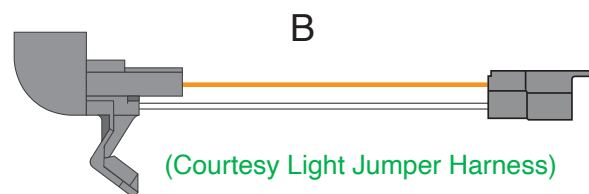

Mating connector is plugged into Accessory Connector

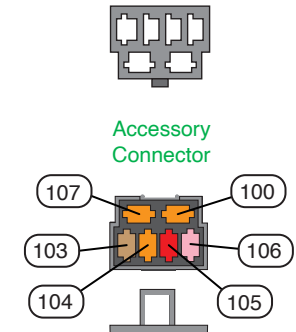

Photo #3



1968



Photo #4

1970

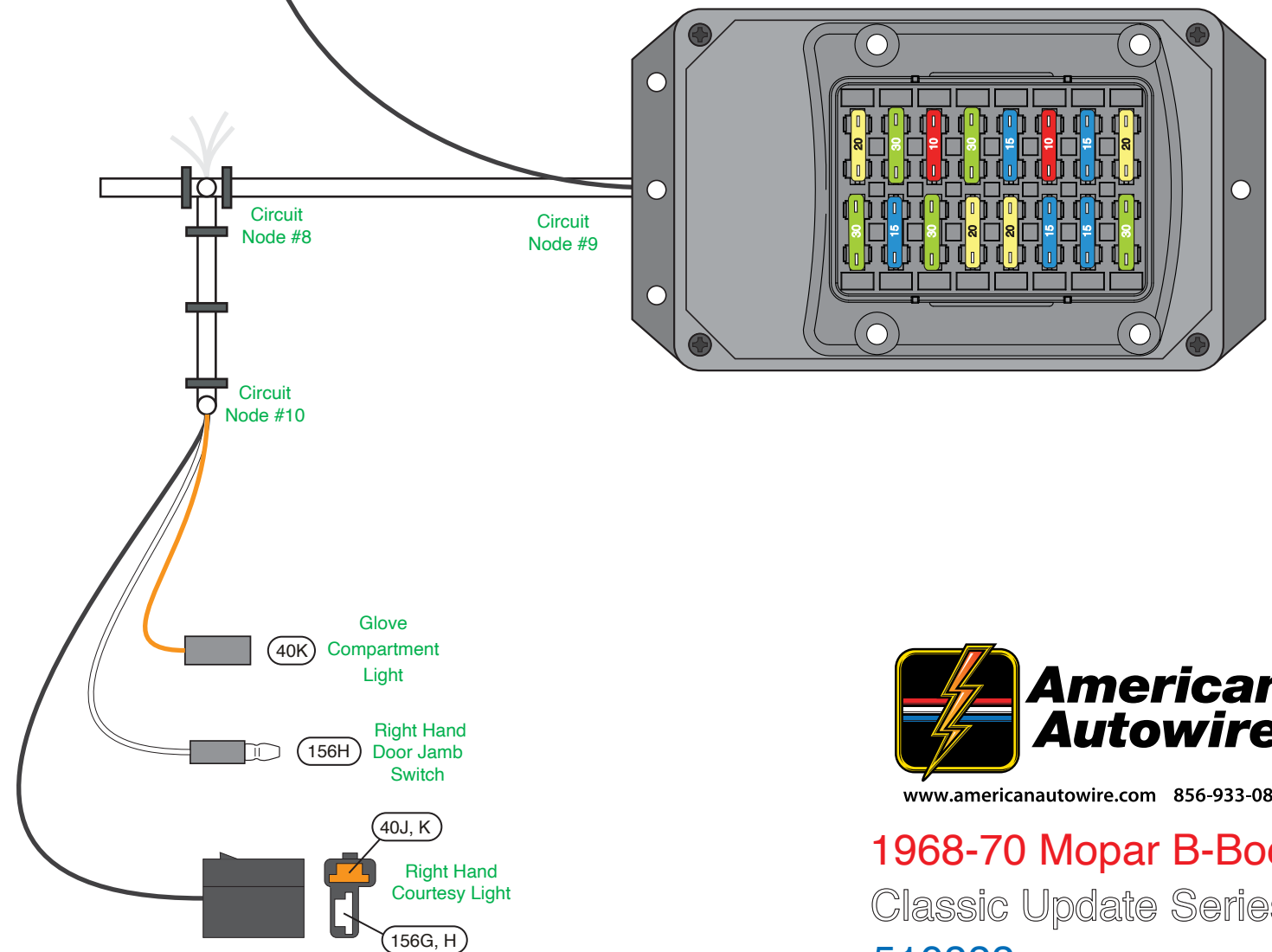

www.americanautowire.com 856-933-0801

1968-70 Mopar B-Body Classic Update Series

510888 92973525 Rev 1.0 6/22/2023

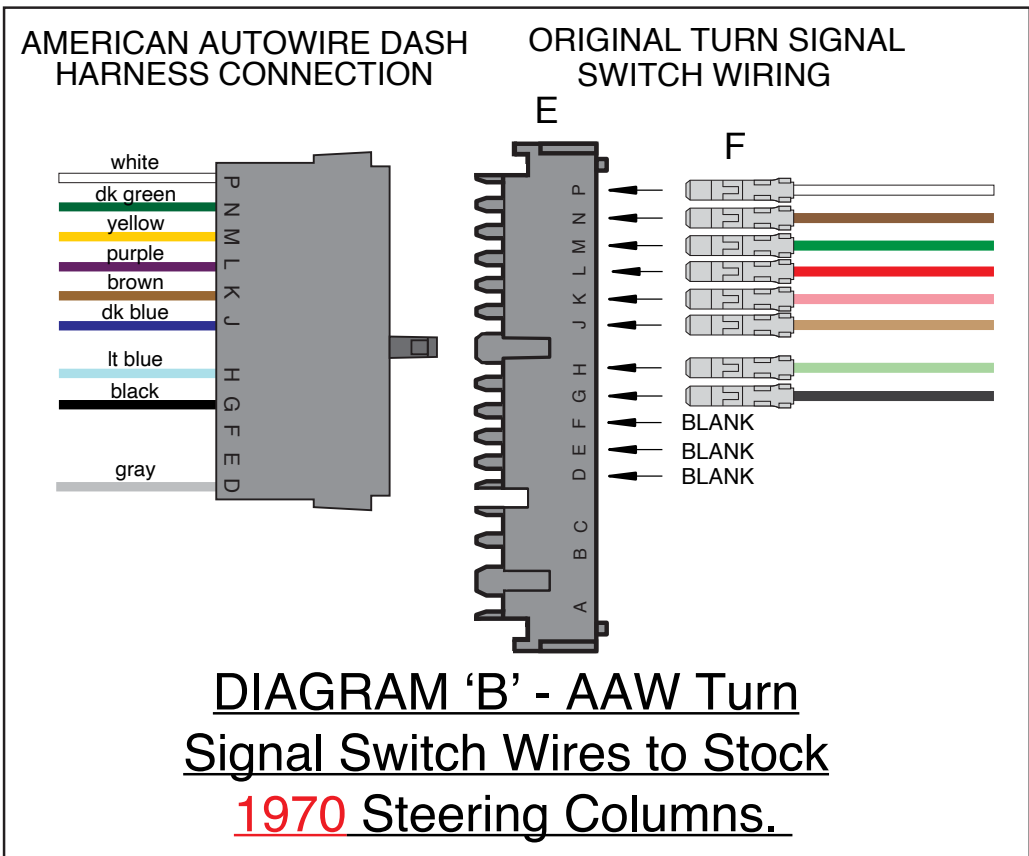
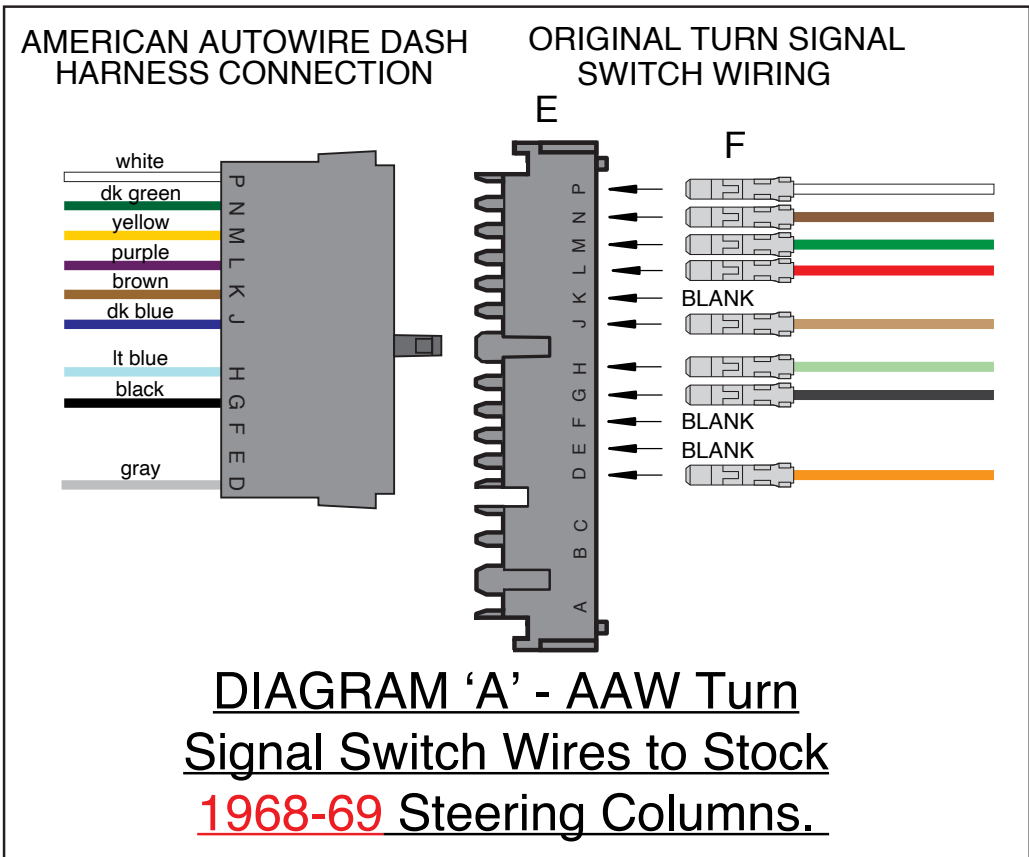

“Table B”

AAW Turn Signal Switch wires to stock 1968-70 Mopar B-body Turn Signal Switch

AAW Wire #	AAW Wire Color	AAW Wire Printing	Connector Cavity AAW	B-Body Turn Signal Switch Wire Color	Aftermarket Turn Signal Switch Wire Color
17B	White	Brake SW	P	White	White
19	Dark Green	Right Rear Turn	N	Brown	Brown
18	Yellow	Left Rear Turn	M	Dark Green	Dark Green
16B	Purple	Turn Switch Feed	L	Red	Red
27B	Brown	Turn SW – Hazard	K	None (1968-69) or Pink (1970)	None or Pink
15A, B	Dark Blue	Right Front Turn	J	Tan	Tan or Gray
14A, B	Light Blue	Left Front Turn	H	Light Green	Light Green or Black/Green
28	Black	Horn Relay Ground	G	Black	Black
None	None	None	F	None	None
None	None	None	E	None	None
8C, D	Gray	DASH LIGHTS	D	Orange (1968-69) or None (1970)	Orange

Note: Remove the original Turn Signal Switch Connector and replace it with the AAW 14-way connector “E”. Crimp on terminal “F” to each of the original Turn Signal Switch wires and plug them into connector “E” (see Parts Kit 92973547). Use “Table B” above to align the wires. Also, for all of the vehicles, the Steering Column Horn Button switches ground for the Horn Relay, which then switches power to the Horns, similar to the AAW design.



www.americanautowire.com 856-933-0801

1968-70 Mopar B-Body
Classic Update Series
510888 92973525 Rev 1.0 6/22/2023

Ignition Switch Connections:

Factory MOPAR Column Ignition Switch Connection

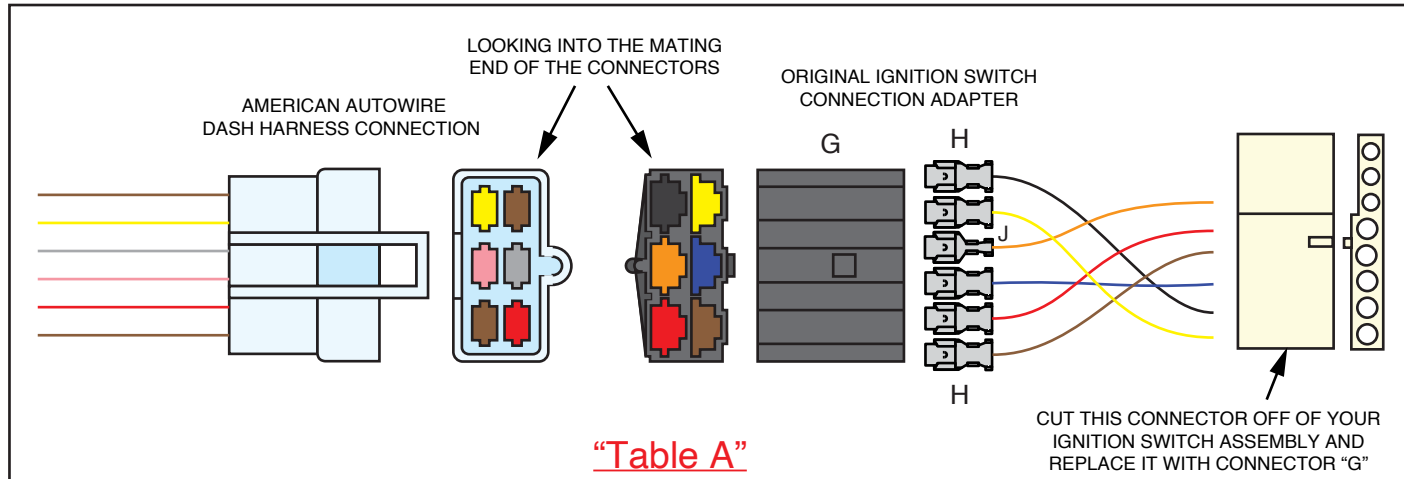

“Table A”

Mopar B-Body 1968-70 Ignition Switch Wires

AAW Wire #	AAW Wire Color	AAW Wire Printing	Wire Description	B-Body Wire Color
5	Yellow	no printing	Start	Yellow
4A, B	Brown (double)	IGNITION SW ACCY	12V Accessory Feed	Black
3A	Pink	IGNITION FEED	12V Ignition Feed	Dark Blue
8B, C	Gray (double)	DASH LIGHTS	Illumination Light	Orange
7	Brown	no printing	Resistor Bypass	Brown
2B	Red	12V BATTERY	12V Battery Feed	Red

Note: Be sure to align the B-Body wire with the corresponding AAW wire in the 6-way connector “G”. Crimp on terminal “J” for the thinner wires and terminal “H” for the thicker wires (see Parts Kit 92973547). The two additional thin red wires in the original stock Ignition Switch Connector Pigtail are for the Key-in-Ignition Warning Buzzer and will not be used and can be taped back.

Aftermarket GM Style Column-Mounted Ignition Switch Connection

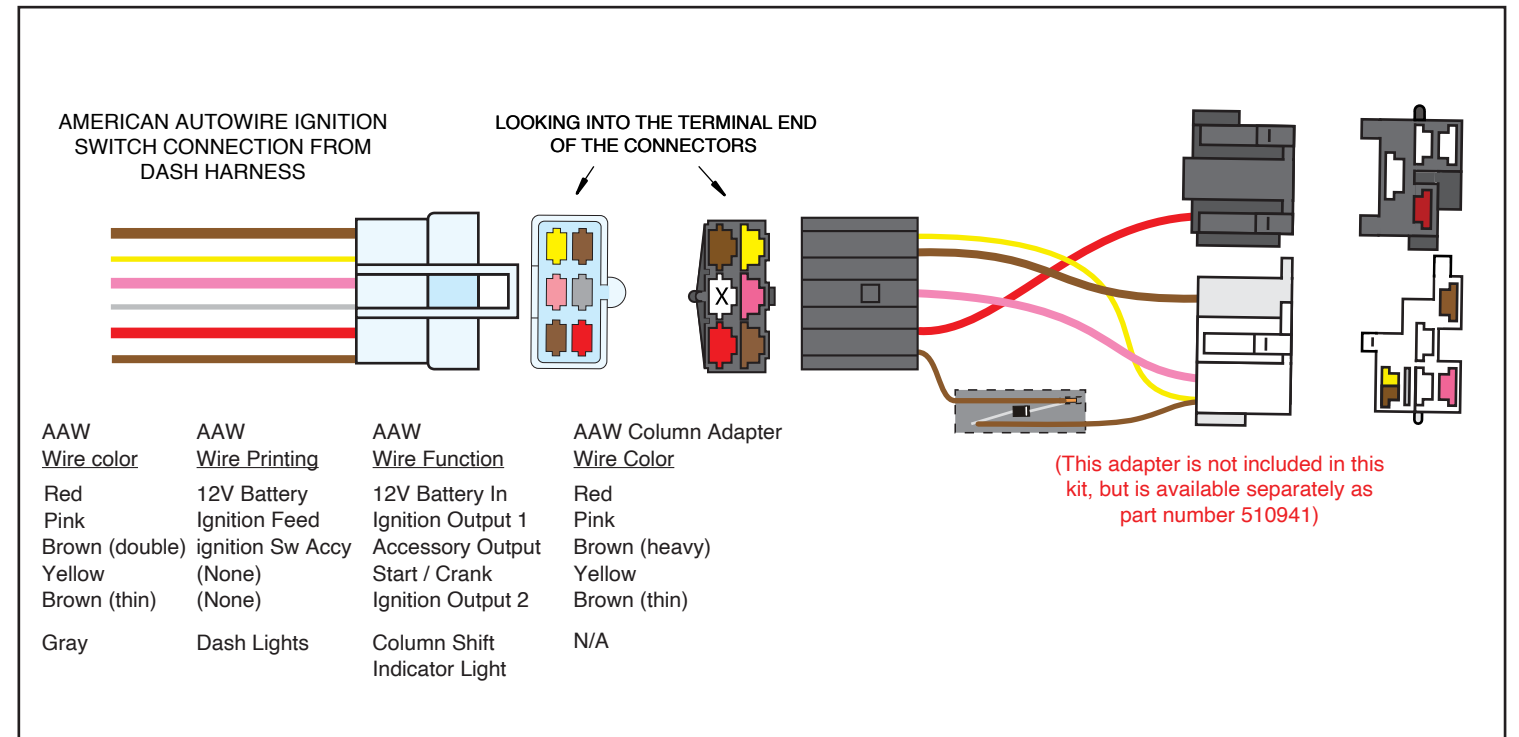

AAW Wire color	AAW Wire Printing	AAW Wire Function	AAW Column Adapter Wire Color
Red	12V Battery	12V Battery In	Red
Pink	Ignition Feed	Ignition Output 1	Pink
Brown (double)	ignition Sw Accy	Accessory Output	Brown (heavy)
Yellow	(None)	Start / Crank	Yellow
Brown (thin)	(None)	Ignition Output 2	Brown (thin)
Gray	Dash Lights	Column Shift Indicator Light	N/A

(This adapter is not included in this kit, but is available separately as part number 510941)



American Autowire

www.americanautowire.com 856-933-0801

1968-70 Mopar B-Body Classic Update Series

510888 92973525 Rev 1.0 6/22/2023

Fuse Box lid

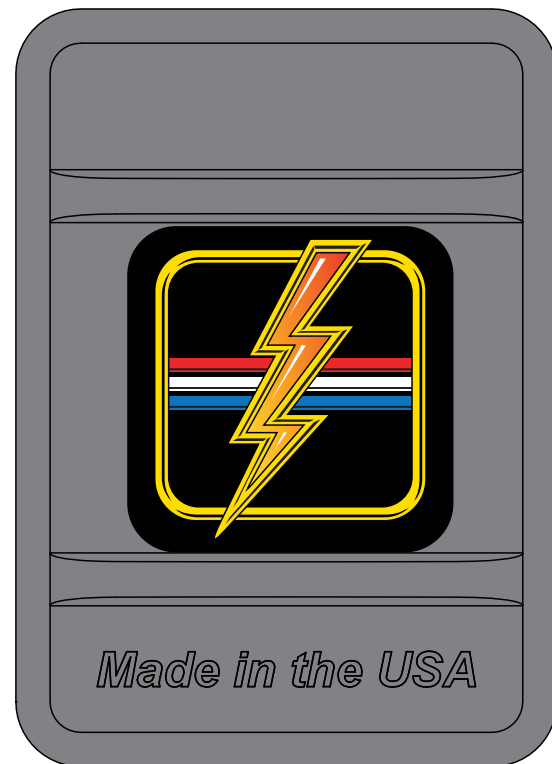

Fuse label on inside of Fuse Box lid

Batt - Spare 30A - BAT	1	9	Wiper 20A - ACC
Clock/Radio 15A - BAT	2	10	Heat/AC 30A - ACC
Power Seat 30A - BAT	3	11	Radio 10A - ACC
Cigar - Lighter 20A - BAT	4	12	Engine Fan 30A - ACC
Power Locks 20A - BAT	5	13	Turn 15A - IGN
Stop/Courtesy 15A - BAT	6	14	Gauges, B/U 10A - IGN
Hazard 15A - BAT	7	15	Elec. Choke 15A - IGN
Pwr. Window 30A - IGN	8	16	Fuel Pump 20A - IGN

Fuse Values and Locations

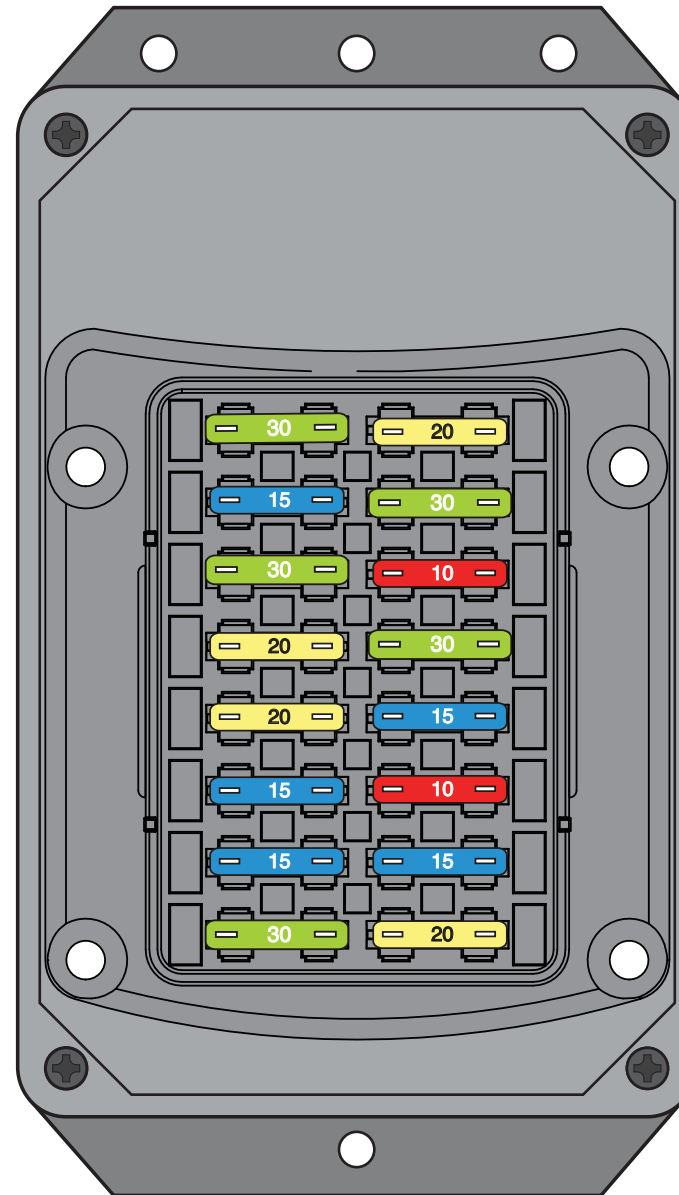

Fuse/Circuit table

Fuse #	Fuse Block Cover Label	Fuse Rating	Description
1	Bat-Spare	30A	Battery feed spare
2	Clock - Bat	15A	Battery feed for a Clock and a Radio.
3	Power Seats	30A	Battery feed for optional Power Seats.
4	Cigar - Lighter	20A	Battery feed for Cigar Lighter.
5	Power Locks	20A	Battery feed to Power Locks.
6	Stop / Courtesy	15A	Battery feed for Brake Lights and Courtesy Lights.
7	Hazard	15A	Battery feed for optional Hazard Lights and optional battery feed.
8	Power Window	30A	Ignition feed for optional Power Windows.
9	Wiper	20A	12V Accessory feed for Wiper/Washer system.
10	Heat / AC	30A	12V Accessory feed for Heater/AC System.
11	Radio	10A	12V Accessory "on-off" feed to Radio.
12	Engine Fan	30A	12V Accessory for an optional Electric Fan System, Relay key-on trigger
13	Turn	15A	Ignition feed for the Turn Signals.
14	Gauges, 68 B/U Lamps	10A	Ignition feed for Dash Gauges/Warning Lights, Back Up Lamps.
15	Electric Choke, 69-70 BU Lamps	15A	Ignition feed for an Electric Choke, ECM Ignition Feed, Back Up Lamps.
16	Fuel Pump	20A	Ignition feed for an Electric Fuel Pump



92971549

Plug this connector into the 6-way Floor Console connector, on your Dash Harness. See Circuit Node #7, on pg 4 of your Dash instruction dwg 92971527.

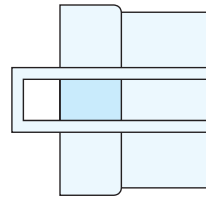

NOTES:

1. Bulbs #90 and #1895 are required for this kit, but are **NOT INCLUDED** with this kit; however they are available in any auto parts store.

2. If you need to replace your **original** A/T Back-up Switch pigtail 2-way connector, the replacement 2-way connector and terminals are provided with this kit.

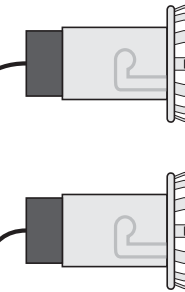

Plug these sockets, into your Floor Console courtesy light housings

bulb #90 is required - **NOT INCLUDED**

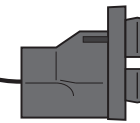

Plug this socket, into your A/T "PRNDL" light housing

bulb #1895 is required - **NOT INCLUDED**

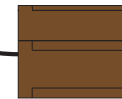

Plug this connector, onto your A/T Back-up Switch (1968)



**American
Autowire**

www.americanautowire.com 856-933-0801

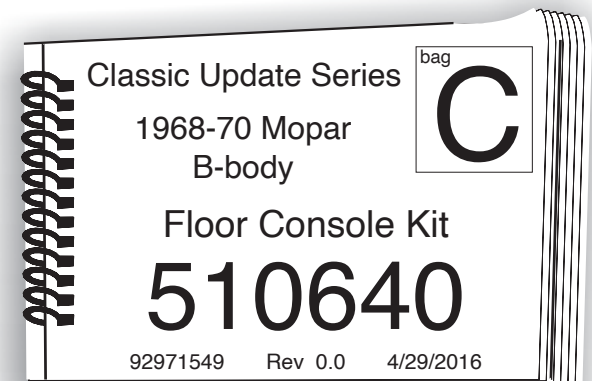

"J" Clamp

Two "J-Clamps" (item "T" on this page) have been provided to retain the Cluster Kit Wiring in place (see photographs on pages 5 and 6).

Splice Clips

Two Splice Clips, plus one spare (item "V" on this page) have been provided for the circuit 8 and circuit 39 splices (see pages 2 and 3).

NOTE: This kit **WILL NOT** support the use of a factory ammeter. A voltmeter is recommended as a good alternative.

GENERAL DESCRIPTION OF WIRES

Connector D – This connector will plug into the mating Connector B of the Dash Harness.

Wire Color	Printing	Circuit #	Description
1. Temperature Gauge			
Dark Green	WATER TEMP SENDER	35	This wire is for your Coolant Temperature Gauge.
2. Brake Warning Light			
Tan	BRAKE LIGHTS/SWITCH	33	This wire is for your Brake Warning Light.
3. Oil Pressure Warning Light (All non-Rallye Clusters)			
Dark Blue	OIL PRESSURE SENDER	31	This wire is for your Oil Pressure Warning Light.
4. Oil Pressure Gauge (All Rallye Clusters)			
Dark Blue	OIL PRESSURE SENDER	31	This wire is for your Oil Pressure Gauge.
5. Fuel Gauge			
Tan	GAS GAUGE	30	This wire is for your Fuel Gauge.
6. Tachometer (loose wire)			
White	COIL --> TACH	121	This wire is for your optional Tachometer or an Aftermarket Tachometer.
7. Right Turn Light			
Dark Blue	RIGHT DASH IND	15	This wire is for your Right Turn Signal Indicator Light.
8. Left Turn Light			
Light Blue	LEFT DASH IND	14	This wire is for your Left Turn Signal Indicator Light.
9. High Beam Indicator Light			
Light Green	HI BEAM INDICATOR LIGHT	11	This wire is for your High Beam Indicator Light.

Connector E – This connector will plug into the mating Connector A of the Dash Harness.

Wire Color	Printing	Circuit #	Description
1. 12V Ignition Feed			
Pink	12V IGNITION	39	This wire is used to provide 12V Ignition Voltage to the Oil Pressure Warning Lamp, the Brake Warning Lamp, the Optional Tachometer, or any other Aftermarket Gauges that you may add.
2. Dash Illumination Lights			
Gray	DASH LIGHTS	8	This wire is for your Dash Illumination Lights, your Optional Clock Light, your Optional Tachometer Light, or an Illumination Light of any other Aftermarket Gauge.
3. Ground			
Black	GROUND	150	This wire is for your Cluster Ground or the ground of an Aftermarket Gauge.
4. 12V Accessory Feed to the Constant Voltage Regulator (loose wire) for all Rallye Clusters			
Brown	no printing	4	This wire is used to provide a 12V Accessory Feed to your Constant Voltage Regulator.
5. Clock (loose wire)			
Yellow	CLOCK BAT	99	This wire is used to provide a 12V Battery feed for your Optional Clock (Rallye Clusters).

Connector F – This connector will plug into the mating connector C of the Dash Harness.

It is only used when connecting to an Aftermarket Electric Speedometer (see page 6 for details). Follow the Electric Speedometer Manufacturer's Instructions when installing these wires.

For Typical Aftermarket Gauge Connections, see page 4.

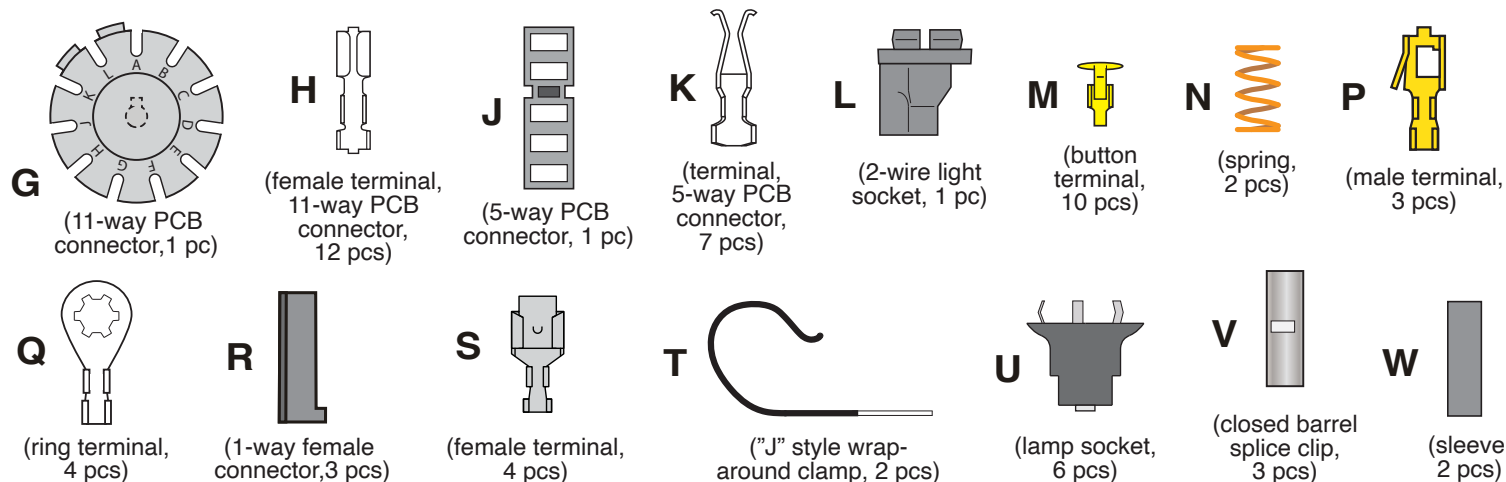

WIRE CONNECTIONS

Non-Rallye Cluster (see pages 2 and 5)

Splices

If you have the Optional Clock or the Optional Tachometer, you will need to splice in an additional gray #8 wire for the separate Illumination Light of the Clock or the Tachometer (see page 2).

If you have the Optional Tachometer, you will need to splice in an additional pink #39 wire for the 12V Ignition feed for the Tachometer (see page 2).

Printed Circuit Board Connector G

Route wires #11, #14, #15, #30, #31, #33 and #35 from Connector D to the Printed Circuit Board (PCB) Connector G (see page 2). Route wires #8 and #39 from Connector E to the PCB Connector G. **Note: Connector G is a "Pull to Seat Connector"**. Cut to length, install terminal H, extend the wires beyond Connector G, insert the wires into the side of the connector, and pull to seat the terminals in the connector.

Dash Illumination Lights

The Dash Illumination Lights are included on the PCB; however you will still need a separate Illumination Light Socket if you have an Optional Clock or an optional Tachometer. Route the gray #8 wire (that you previously spliced in) to the back of the Clock or the Tachometer, cut to length, slide the wire through a socket U, and then crimp on a terminal M.

Ground

Route the black #150 wire from Connector E to a screw on the back of the Cluster that will provide a good path to ground (reference photograph on page 5). Cut to length, crimp on terminal Q and remove the screw and attach the ground ring terminal under the screw and reattach.

Clock

If you have the optional Clock, plug the yellow #99 wire into Connector E. Route the #99 wire from Connector E to the Clock. Cut to length, crimp on terminal S and install into connector R. You can now connect to the clock.

Tachometer

If you have the optional Tachometer you will have to route the extra pink #39 wire (that you previously spliced in) to the Tachometer. Cut to length, crimp on ring terminal Q (slide on sleeve W first) or crimp on terminal S (and plug terminal S into Connector R). One of these will be your 12V Ignition feed to the Tachometer. Plug the white #121 wire into Connector D. Route wire #121 from Connector D to the Tachometer. Cut to length and, crimp on ring terminal Q (slide on sleeve W first) or crimp on terminal S (and plug terminal S into Connector R). Install the appropriate connection onto your Tachometer Pulse location.

Rallye Cluster (see pages 3 and 6)

Splices

For the Cluster Illumination, you will have to splice in four gray #8 wires to the #8 wire coming from Connector E (see page 3) for the Illumination Light Sockets and the PCB Connector. There will always be three sockets. When there is no Optional Clock or Optional Tachometer, all three Illumination Light Sockets connect to the Cluster. If you have a Clock or a Tachometer, then two Lights go to the Cluster and one Light goes to the Clock or Tachometer.

If you have the Optional Tachometer, you will need to splice in an additional pink #39 wire for the 12V Ignition feed for the Tachometer (see page 3).

Printed Circuit Board Connector J

Plug the brown #4 wire into Connector E. Route wires #30, #31, and #35 from Connector D to the Printed Circuit Board (PCB) Connector J (see page 3). Route wire #4 from Connector E to the PCB Connector J. Route wire #8 from the splice to the PCB Connector J. Cut the wires to length, crimp on terminal K, and plug the wires into Connector J.

Dash Illumination Lights

Route the three gray #8 wires (that were previously spliced in) to the back of the Cluster (see page 3). Two Light Sockets will go to the Cluster and one Light Socket to either the Optional Clock or the Optional Tachometer, or all three Light Sockets will go to the Cluster. Either way, cut the gray #8 wires to length, slide each wire through a socket U, and then crimp on a terminal M.

Brake Warning Light (Socket L)

Route the tan #33 wire from Connector D to the Brake Warning Light socket L. Cut to length, crimp on terminal P and plug into socket L. Route the remaining pink #39 wire from the splice to the Brake Warning Light socket L. Cut to length, slide on the 2-way socket L, and slide on spring N to the pink #39 wire, and then crimp on terminal M.

Ground

Route the black #150 wire from Connector E to a screw on the back of the Cluster that will provide a good path to ground (reference photograph on page 6). Cut to length, crimp on terminal Q and remove the screw and attach the ground ring terminal under the screw and reattach.

Clock

If you have the optional Clock, plug the yellow #99 wire into Connector E. Route the #99 wire from Connector E to the Clock. Cut to length, crimp on terminal S and install into Connector R. You can now connect to the clock.

Tachometer

If you have the optional Tachometer you will have to route the extra pink #39 wire (that you previously spliced in) to the Tachometer. Cut to length, crimp on ring terminal Q (slide on sleeve W first) or crimp on terminal S (and plug terminal S into Connector R). One of these will be your 12V Ignition feed to the Tachometer. Plug the white #121 wire into Connector D. Route wire #121 from Connector D to the Tachometer. Cut to length and, crimp on ring terminal Q (slide on sleeve W first) or crimp on terminal S (and plug terminal S into Connector R). Install the appropriate connection onto your Tachometer Pulse location.



www.americanautowire.com 856-933-0801

INSTRUMENT CLUSTER
Classic Update Series
1968-70 Mopar B-Body
510785
92972819 Rev 0.0 1/7/2020

bag
H

USE THIS SHEET TO CONNECT TO AN ORIGINAL **NON-RALLYE** 1968-70 MOPAR B-BODY
FACTORY INSTRUMENT CLUSTER

Classic Update Series

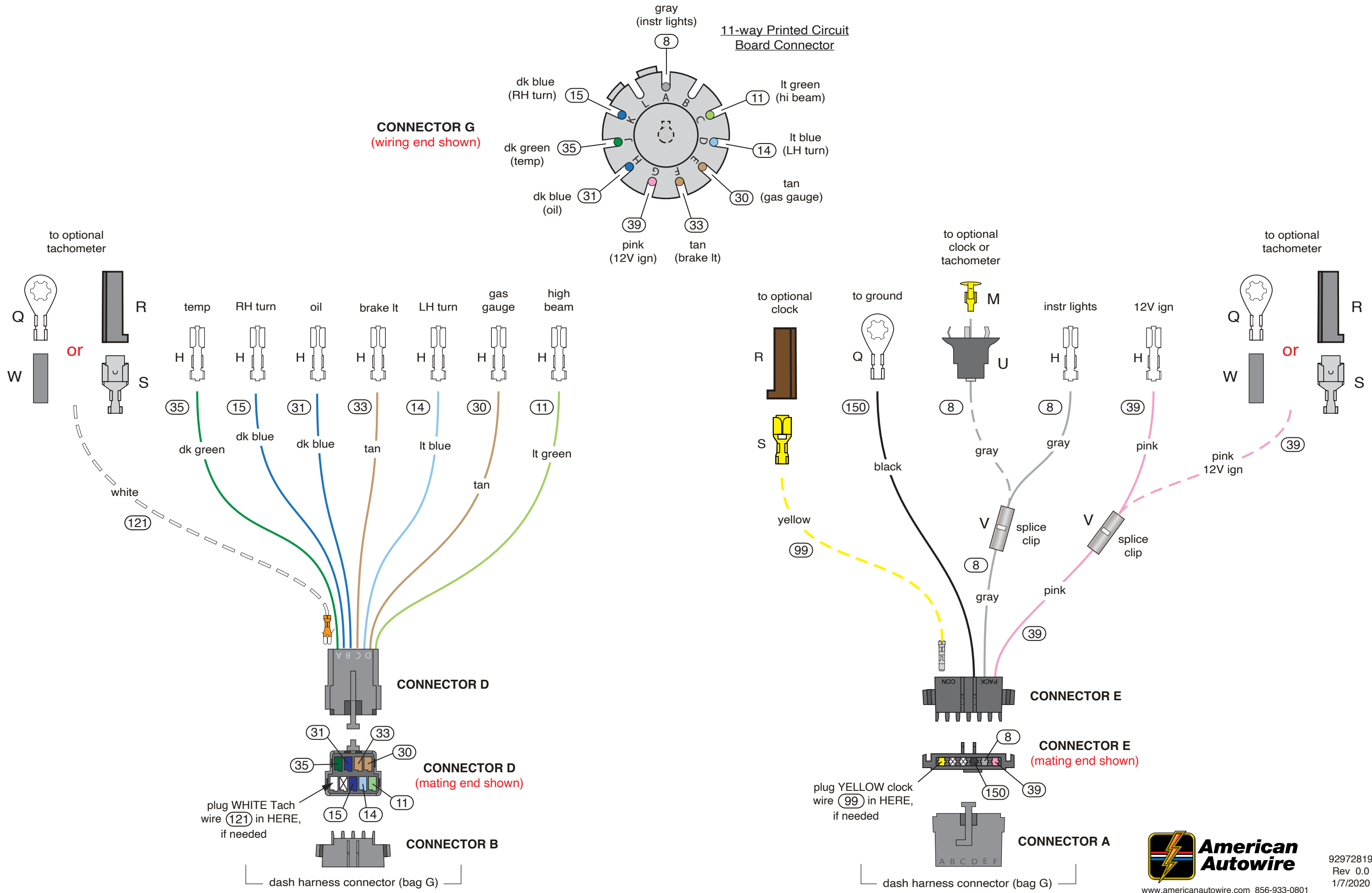

USE THIS SHEET TO CONNECT TO AN ORIGINAL RALLYE 1968-70 MOPAR B-BODY FACTORY INSTRUMENT CLUSTER

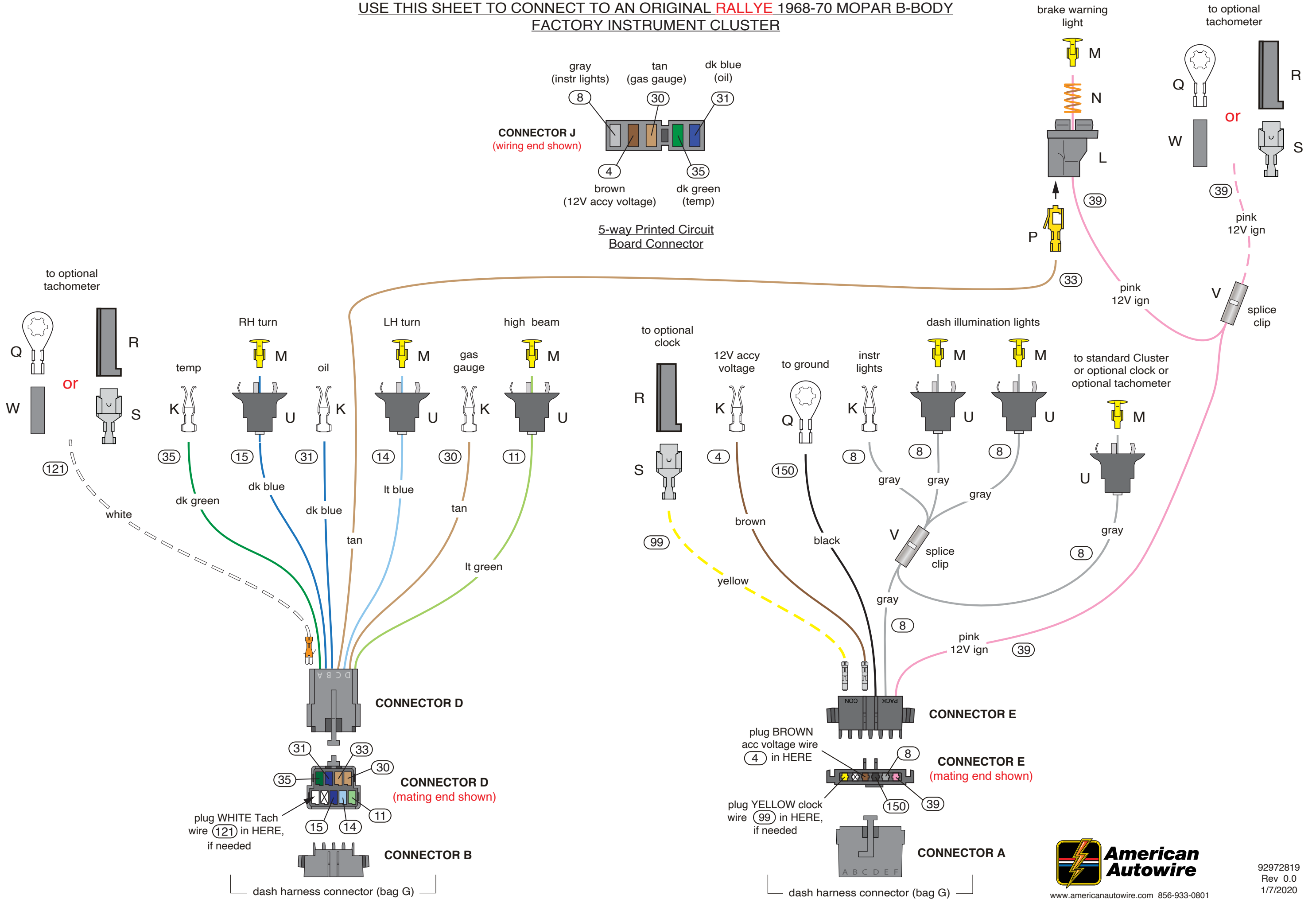

TYPICAL AFTERMARKET GAUGE CONNECTIONS (BLADE TYPE CONNECTIONS SHOWN)

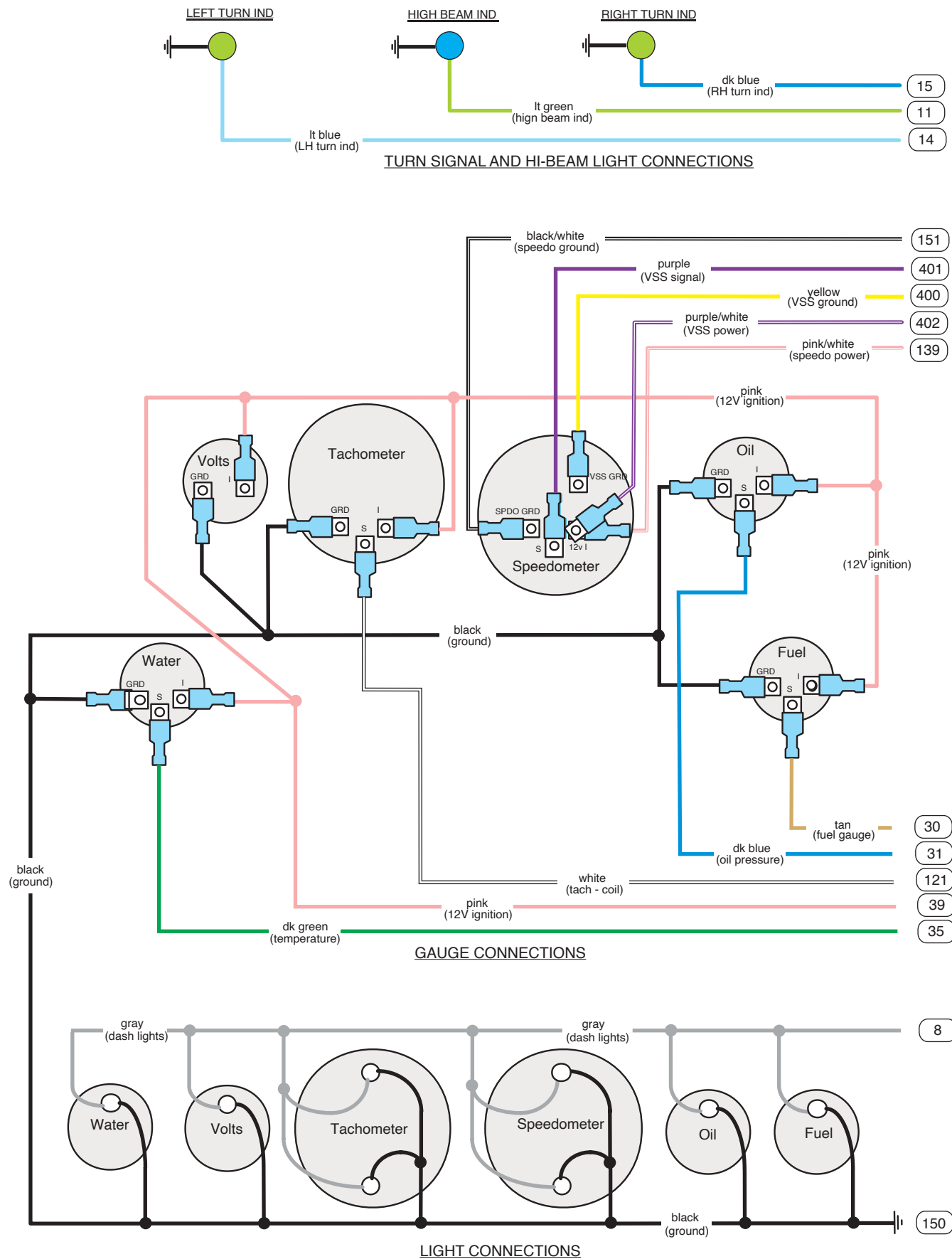

TYPICAL ELECTRIC SPEEDO CONNECTIONS

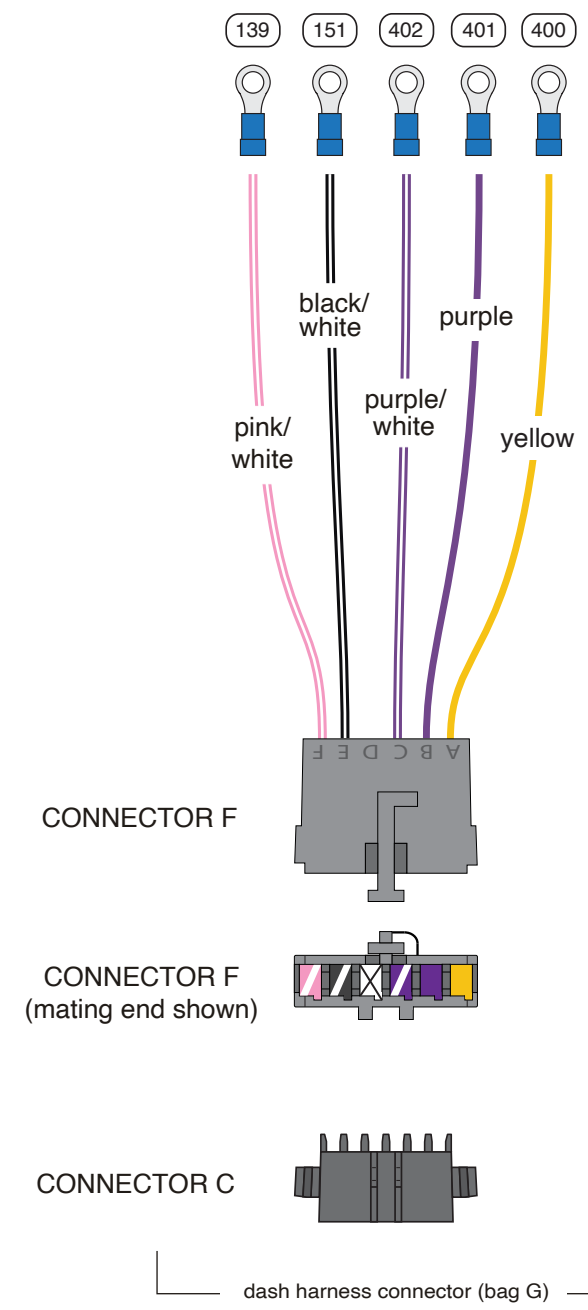

Below are some general instructions for hooking up an electric speedometer. This connector and these instructions will ONLY be used in the event that you are utilizing an aftermarket electric speedometer. If your car does NOT have an electric speedometer, this connection will NOT be used and should not be plugged onto your dash harness. It is best to consult the speedometer manufacturer's instructions if you have any questions.

- Yellow** VSS Ground Connect to VSS "-" on speedometer.
- Purple** VSS Signal Connect to VSS input on speedometer.
- Purple/White** VSS Power Connect to 12V power on speedometer.
- Black/White** Speedo Ground Connect to ground on speedometer.
- Pink/White** Speedo Power Connect to 12v power on speedometer. **NOTE:** This wire will double onto the same stud as the purple/white VSS power wire from above.

NON-RALLYE CLUSTER

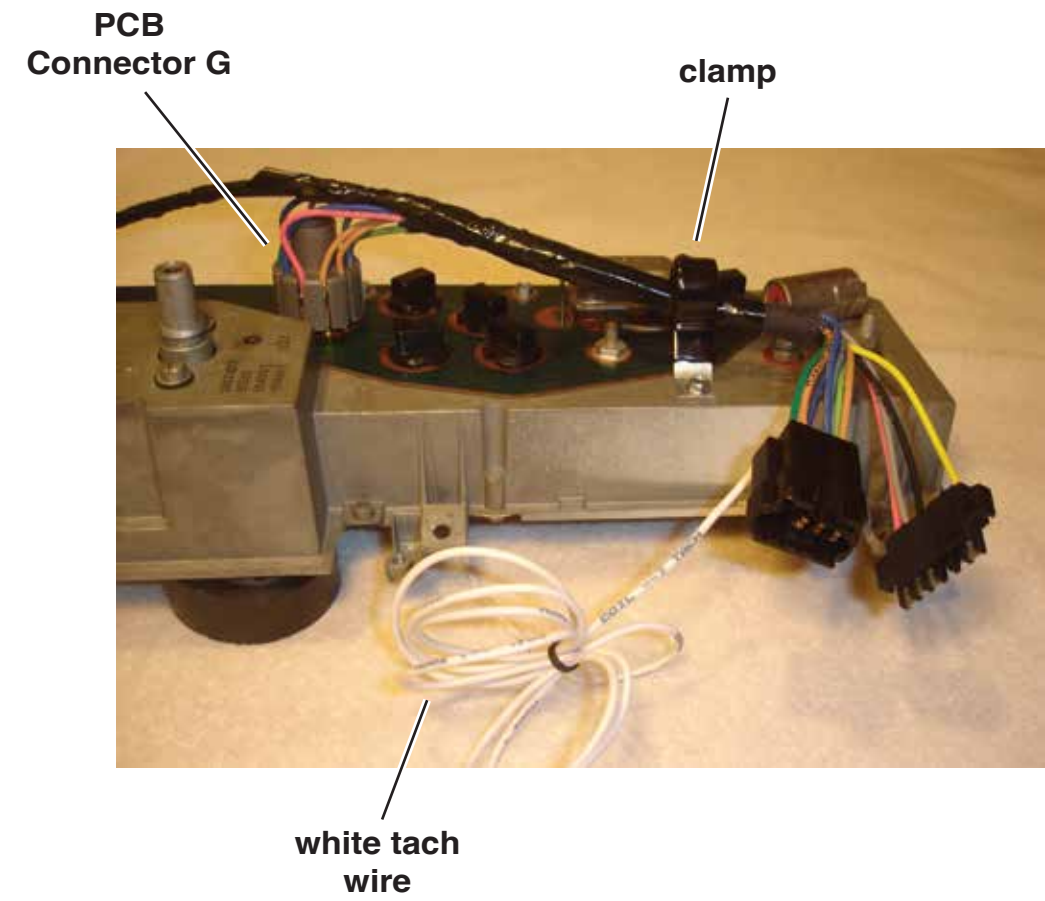
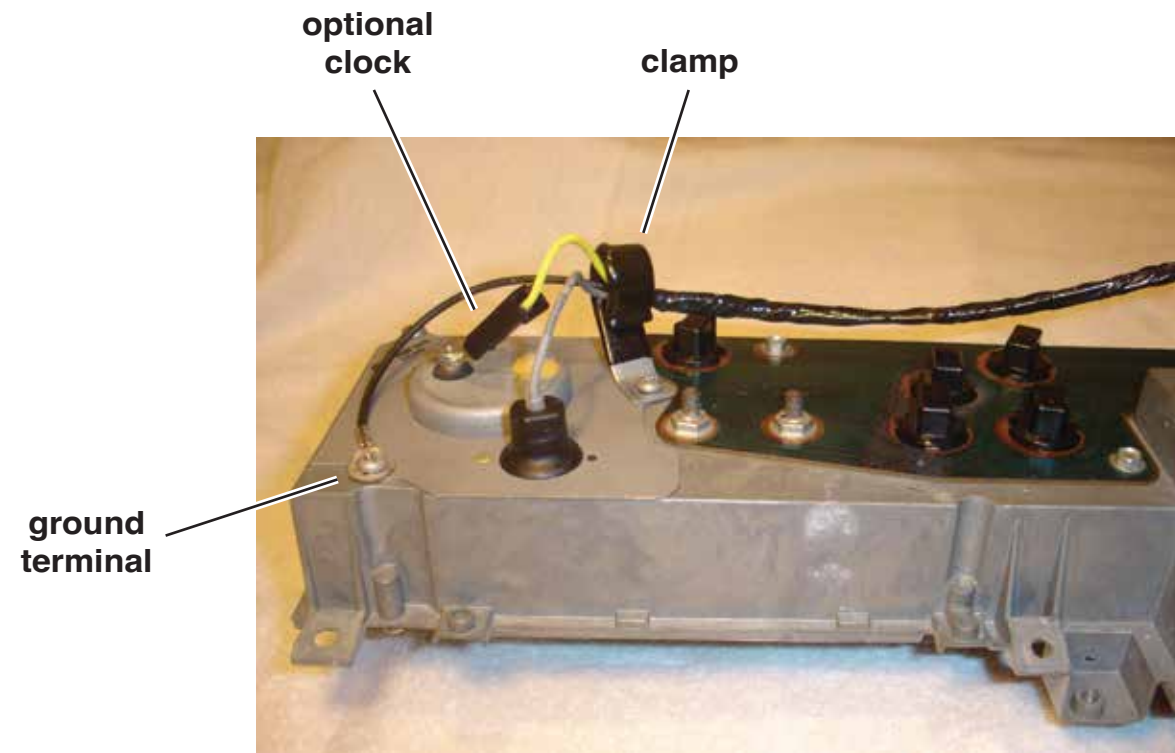

RALLYE CLUSTER

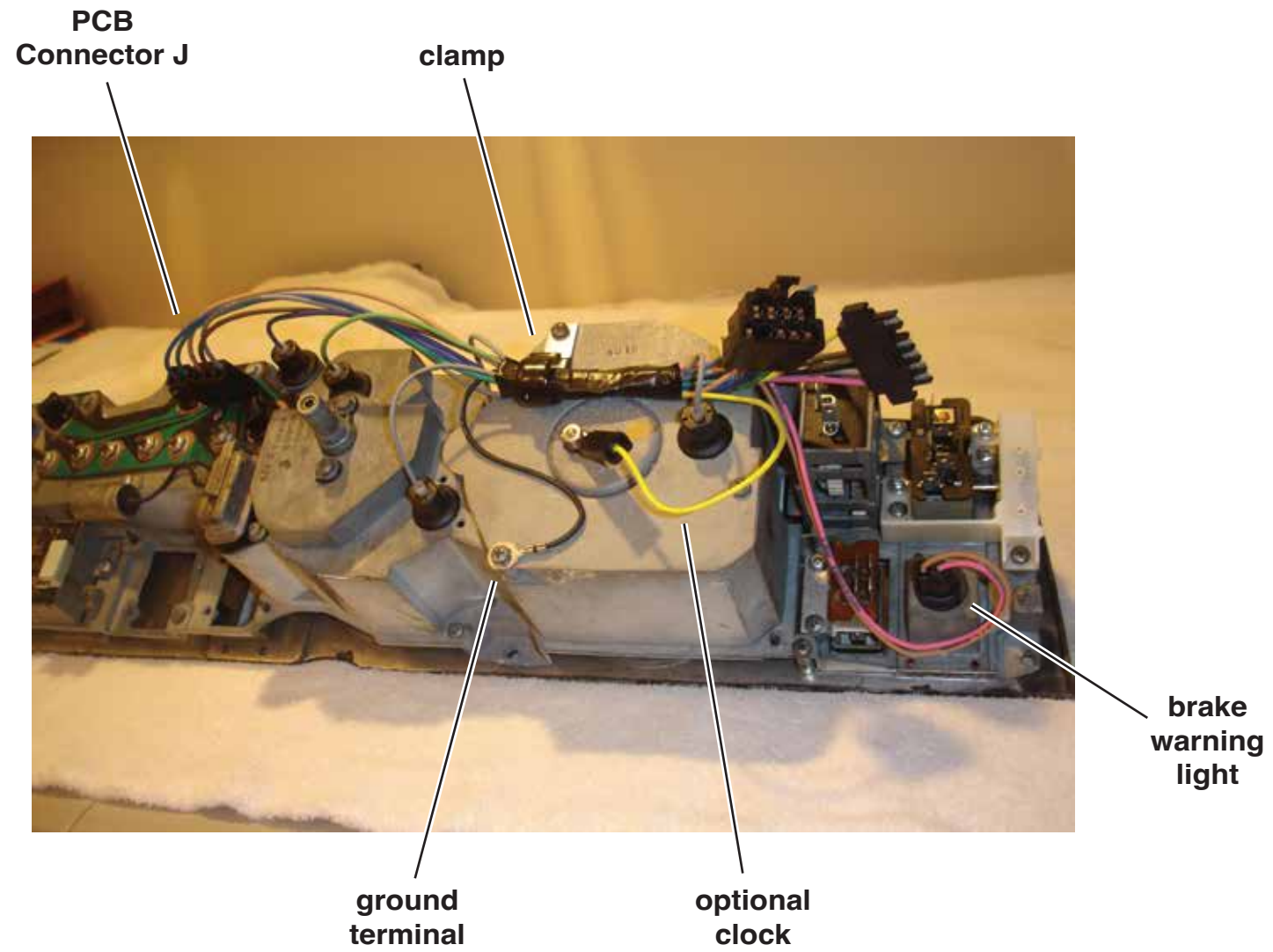

Electric Speedo VSS extension connection:

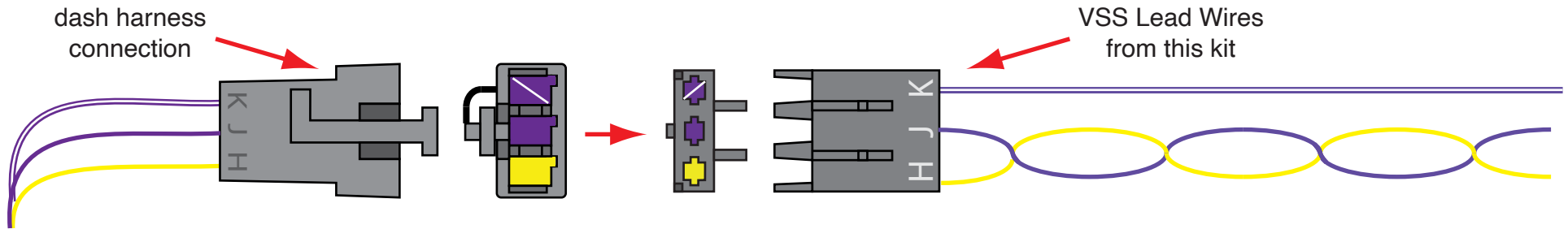

If you are using an aftermarket electric speedometer in your vehicle, you will need to connect the vehicle speed sensor (VSS) Lead Wires from this kit to the dash side connection of your dash harness. The yellow and solid purple wires must remain twisted together as shown above. These three wires will need to pass through the firewall or floor of your vehicle down to the vehicle speed sensor unit in the transmission. Generally, the solid purple wire connects to the “signal” lead, the yellow wire connects to the “ground” lead, and the purple/white stripe wire connects to the “12 volt power” lead on the vehicle speed sensor assembly. However, you should consult the directions that came with your gauges, and connect your vehicle speed sensor per the manufacturer’s instructions.



www.americanautowire.com 856-933-0801

VSS LEAD WIRES
Various Applications
Classic Update Series

510730

92972371 Rev 0.0 4/9/2019

bag
V

Optional Wires to be plugged into the 9-way Rear Body Wiring Connector.

Obtain the Rear Body Wiring Harness **510639 in Bag M**. If you have any of the following, plug these wires into the Rear Body Harness 9-way connector first (see pages 4-9):

Third Brake Light, plug in the loose light blue “THIRD BRAKE LIGHT” wire (circuit 17).

Trunk Light, plug in the loose orange “12V BATTERY-FUSED” wire (circuit 40).

Rear Door Jamb Switches for a 4-door vehicle with Courtesy Lights, plug in the loose white “CTSY GROUND” wire (circuit 156).

Routing and Connecting the Rear Body Kit.

Connect the Rear Body Harness 9-way connector to the 9-way Rear Body connector of the Main Dash Harness **510635**, route the Rear Body Harness from the left Side Cowl area to the rear of the vehicle following the original wire routing. Use the original factory retainers (tabs and clips) to attach the wiring to the vehicle.

Note: See the Legend on page 3 for the different connectors, terminals, grommets and pigtails that are available in the Parts Kit 92971544.

Dome Light (pages 4 to 9) The Dome Light in these vehicles requires a 12 volt B+ feed wire and a Courtesy Switch ground wire to the Light. The orange “12V BATTERY-FUSED” wire (circuit 40A) provides the B+ feed, and the white “CTSY GROUND” wire (circuit 156A) provides the switched ground wire. Obtain the **Dome Light Socket & Pigtail “J”** (from the Parts Kit) and install the Socket into the Dome Light Housing. **Note: The Dome Light requires a #Y1004 Light Bulb – not included in this kit.** Route the orange and white wires along the LH Roof Bow and forward to the LH A-Pillar. Route the wires down through the A-Pillar to the 2-way mating connector of the Dash Harness. Cut to length, crimp on terminals “JJ” and plug into the 2-way connector “HH”. Plug the orange wire into cavity A and the white wire into cavity B. You can plug this connector to the Dash Harness.

If you wish to use your **original Dome Light Harness**, cut the 2-way connector off where it mates to the original Instrument Panel Harness, in the LH Side Cowl, crimp on terminals “JJ” and plug into connector “HH”. Your original pink wire will mate with the AAW orange wire (cavity A in the connector) and the original yellow wire will mate with the AAW white wire (cavity B in the connector). You can now plug this connector to the 2-way Dome Light Connector of the Dash Harness.

<u>Wire Color</u>	<u>Printing</u>	<u>Wire Number</u>
Orange	12V BATTERY-FUSED	40A
White	CTSY GROUND	156A

Door Jamb Switches – Rear Doors (pages 4, 6, 7, and 8) The wiring for the Front Door Jamb Switches is included in the Dash Harness, see **Dash Harness Kit 510635** for the Front Door Jamb Switch connections. If you have Rear Door Jamb Switches route the white “CTSY GROUND” wire (circuit 156) in the Rear Body Harness to the LH Rear Door Jamb Switch. Cut to length, slide on sleeve “FF” and crimp on male bullet terminal “CC”. Make a Jumper Harness (as shown on pages 4, 6, 7, or 8) and connect this Jumper Harness to the male bullet terminal “CC” that you just added. You can now route a branch to the LH and RH Rear Door Jamb Switches.

<u>Wire Color</u>	<u>Printing</u>	<u>Wire Number</u>
White	CTSY GROUND	156

Third Brake Light (pages 4 to 9) Obtain the light blue “THIRD BRAKE LIGHT” wire (circuit 17) in the Rear Body Harness and route this wire to the C-Pillar area. Route the wire up the C-Pillar and connect to the Third Brake Light.

<u>Wire Color</u>	<u>Printing</u>	<u>Wire Number</u>
Light Blue	THIRD BRAKE LIGHT	17

Fuel Sender Wire (pages 4 to 9) Obtain the tan “GAS GAUGE” wire (circuit 30) in the Rear Body Harness and route it in the vicinity of the Fuel Tank Sender grommet in the Trunk Floor. Crimp on terminal “R” and plug it into connector “Q”.

Fuel Sender (pages 4 to 9) Obtain the Fuel Tank Connector Pigtail “K” and feed the tan wire of the pigtail through Grommet “AA”. Route the rubber molded connector through the floor and connect to the Fuel Sender on the Gas Tank. Seat the grommet “AA” securely into the floor. Route the tan Fuel Tank Sender wire to the Rear Body Harness connector “Q”, cut to length, crimp on terminal “V” and plug into connector “U”. You can connect the two connectors.

<u>Wire Color</u>	<u>Printing</u>	<u>Wire Number</u>
Tan	GAS GAUGE	30

Trunk Light Assembly (pages 4 to 9) Route the orange “12V BATTERY-FUSED” wire (circuit 40) to your original Trunk Light Wiring Assembly. Cut to length, slide on sleeve “FF” and crimp on male terminal “CC”. Remove the original connector from the Trunk Light Assembly, slide on sleeve “EE” and crimp on female bullet terminal “DD”. You can now make the connection to the black Trunk Light Wire.

<u>Wire Color</u>	<u>Printing</u>	<u>Wire Number</u>
Orange	12V BATTERY-FUSED	40

Various Pigtail Assemblies

Obtain the appropriate Pigtail and Socket Assemblies (shown on page 3) from the Parts Kit **92971544** for your vehicle (see pages 4-9 for your specific model year and vehicle requirements).

Various Grommets

Included in your kit are three different size grommets (shown on page 3) from Parts Kit **92971544** for your Rear Body Harness Installation. Grommet “AA” fits in a 3/4” hole, “BB” fits in a 1/2” hole and “GG” fits in a 7/8” hole. One of the “AA” Grommets will always be used for the tan Fuel Sender wire. The other three grommets (“AA”, “BB”, and “GG”) are used for the License Light and/or Back-up Light wiring. You will have to confirm your grommet hole size in your vehicle and use the proper grommet for that vehicle application. Grommet “AA” may need to have the pass through hole enlarged if you are incorporating more than one wire. Be sure to route the wires through the Grommets, before you crimp any terminals to the wires.

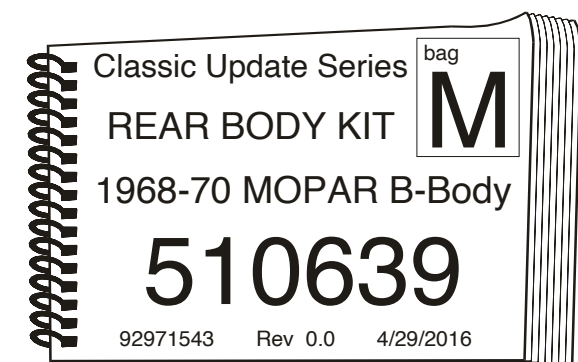

Left Hand Turn Signal Wire (pages 4 to 9) Obtain the yellow “LEFT REAR TURN” wire (circuit 18) from the Rear Body Harness and route it to the LH Tail Light Pigtail (“A” or “C”), cut to length, install terminal “R” or “S” (if you have two LH Tail Lights) and plug into connector “N”. Continue to route the yellow wire to the second LH Tail Light (if equipped) and cut to length, install terminal “R” and plug into the second connector “N”.

Wire Color	Printing	Wire Number
Yellow	LEFT REAR TURN	18

Right Hand Turn Signal Wire (pages 4 to 9) Obtain the dark green “RIGHT REAR TURN” wire (circuit 19) from the Rear Body Harness and route it to the RH Tail Light Pigtail (“B” or “D”), cut to length, install terminal “R” or “S” (if you have two RH Tail Lights) and plug into connector “N”. Continue to route the dark green wire to the second RH Tail Light (if equipped) and cut to length, install terminal “R” and plug into the second connector “N”.

Wire Color	Printing	Wire Number
Dark Green	RIGHT REAR TURN	19

LH Tail Light and Side Marker Wires (all) Route the brown “REAR RUNNING LIGHTS” wire (circuit 9) from the Rear Body Harness to the LH Side Marker Pigtail “L” (if equipped), cut to length, double this wire with the cut off portion, crimp on terminal “Z” and plug into connector “X”. Route the loose piece of wire to the first LH Tail Light Pigtail (“A” or “C”) cut to length, double this wire with the cutoff portion, crimp on terminal “S” and plug into the first LH connector “N”. Route the loose piece of wire to the second LH Tail Light Pigtail (“A” or “C”) (if equipped), cut to length, double this wire with the cutoff portion, crimp on terminal “S” and plug into the second LH connector “N”.

Rear Running Lights and License Light Wires (1969-70 Charger, page 9) Continue routing the brown “REAR RUNNING LIGHTS” wire (circuit 9) to the LH Running Light Pigtail “H”, cut to length, double this wire with the cut off portion, crimp on terminal “S”, and plug into connector “P”. Route the loose piece of wire to the original License Light Pigtail, cut to length. Double this wire with the cut off portion and slide on grommet “GG” (7/8”) over these two wires. Now slide on sleeve “EE” over these two wires and crimp on female bullet terminal “DD”. Continue routing the brown wire to the RH Running Light Pigtail “H”, cut to length, double this wire with the cut off portion and crimp on terminal “S” and plug into connector “P”.

RH Tail Light and Side Marker Wires (all) Route the loose brown wire to the first RH Tail Light Pigtail (“B” or “D”) cut to length, double this wire with the cut off portion, crimp on terminal “S”, and plug into the first RH connector “N”. Route the loose brown wire to the second RH Tail Light Pigtail (“B” or “D”) (if equipped), cut to length, double this wire with the cut off portion, crimp on terminal “S”, and plug into the second RH connector “N”. Route the loose wire to the RH Side Marker Pigtail “L” (if equipped), cut to length, double this wire with the cutoff portion, crimp on terminal “Z” (or terminal “Y” for the 1969-70 Charger) and plug into the RH Side Marker connector “X”.

License Light (all except page 9) From the RH Side Marker, route the brown wire (circuit 9) to the original 1-wire License Light Pigtail, cut to length, slide on grommet (“AA”, “BB”, or “GG”) to the brown wire. Slide on rubber sleeve “EE” and crimp on terminal “DD”. Route this female bullet terminal “DD” through the hole in the Rear Valence Panel, seat the grommet in the hole, and plug the terminal to the original License Light Pigtail.

Wire Color	Printing	Wire Number
Brown	REAR RUNNING LIGHTS	9

Back-Up Lights (pages 4, 5, and 8 with the Back-up Lights in the Tail Light Housing) Obtain the light green “BACK UP LT SW” wire (circuit 24) from the Rear Body Harness and route this wire to the LH Back-Up Light Pigtail “G”, cut to length, double this wire with the cut off portion, install terminal “S”, and plug into connector “P”. Route the loose end of this light green wire over to the RH Back-Up Light Pigtail “G”, cut to length, crimp on terminal “R” and plug into connector “P”.

Back-Up Lights (pages 6, 7, and 9 with Separate Back-up Lights) For the vehicles with the Back-up Lights separated from the Tail Light Housing and located in or below the Rear Bumper, you will not use one of the new Back-up Light Pigtails but will connect to the Original Back-up Light Pigtail.

For Separate Back-Up Lights with a male bullet pigtail (page 7 and 9) Obtain the light green “BACK UP LT SW” wire (circuit 24) from the Rear Body Harness and route this wire up to the existing Back-up Light Wiring grommet hole. Route the wire through either the “AA” or the “GG” grommet to one of the original Back-Up Light Pigtails, cut to length, double this wire with the cut off portion, slide on sleeve “EE” and crimp on female bullet terminal “DD”. Route the loose end of the wire to the other Original Back-up Light Pigtail, cut to length, slide on sleeve “EE” and crimp on terminal “DD”.

For Separate Back-Up Lights with a female bullet pigtail (page 6) Obtain the light green “BACK UP LT SW” wire (circuit 24) from the Rear Body Harness and route this wire to the existing Back-up Light Wiring grommet hole, cut to length, slide on sleeve “FF” and crimp on male bullet terminal “CC”. Obtain the loose light green wire and route the wire from the male bullet terminal “CC” through either the “AA” or the “GG” grommet and then to the LH Back-up Light. Cut to length and slide on sleeve “FF” and crimp on male bullet terminal “CC”. Route another piece of the light green wire, similar to the previous step, but to the RH Back-up Light. Add a sleeve “FF” and crimp another male bullet terminal “CC” as before. For the two light green wires near the first terminal “CC”, slide on sleeve “EE” and crimp on female bullet terminal “DD”.

Wire Color	Printing	Wire Number
Light Green	BACK UP LT SW	24

Tail Light Ground Jumpers These ground Jumpers “M” are used to ground the Side Markers, the Tail Light Sockets, the Running Lights, and the Back-Up Light Sockets. Find a good ground location for the ring terminal near the Trunk Latch.

Left Hand Ground Wire **Note: vehicles that have the Back-up Lights mounted below or in the Rear Bumper do not require a ground wire to the Back-up Lights.**

Obtain the Ground Jumper “M” and locate a good ground for the ground ring terminal and attach it to ground.

Route the black “GROUND” wire (circuit 150) from the Ground Pigtail “M” to the LH Back up Light Pigtail “G” (if equipped), cut to length, double this wire with the cut off portion, crimp on terminal “S” and plug into connector “P”.

Route the black ground wire to the LH Running Light Pigtail “H” (if equipped), cut to length, double this wire with the cut off portion, crimp on terminal “S” and plug into connector “P”.

Route the black ground wire to the first LH Tail Light Pigtail (“A” or “C”), cut to length, double this wire with the cutoff portion, crimp on terminal “S” and plug into the first connector “N”.

Route the black ground wire to the second LH Tail Light Pigtail (“A” or “C”) (if equipped), cut to length, double this wire with the cutoff portion, crimp on terminal “S” and plug into the second connector “N”.

Route the loose black wire to the LH Side Marker Pigtail “L”, cut to length, crimp on terminal “Y”, and plug into the LH Side Marker connector “X”.

Right Hand Ground Wire (Repeat the process for the RH Ground).



Wire Color	Printing	Wire Number
Black	GROUND	150





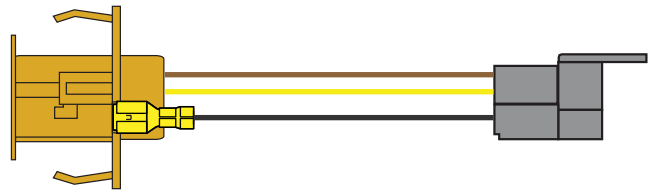
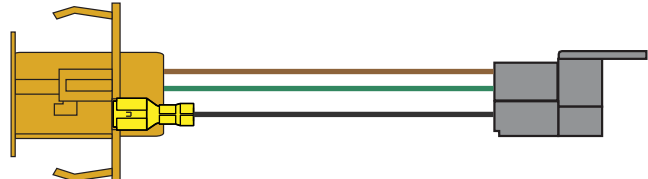
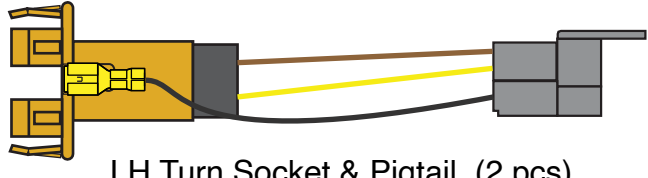
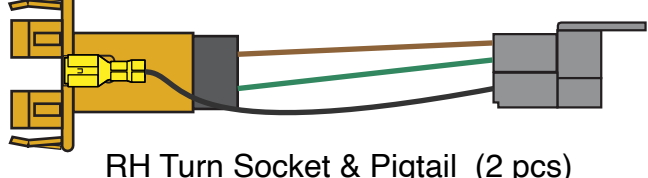

1968-70

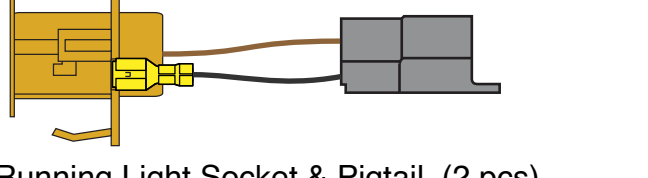



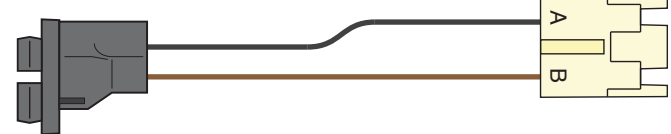
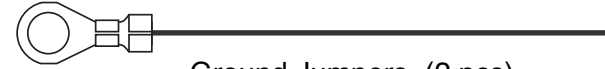
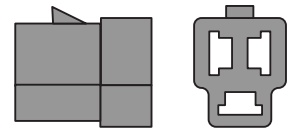

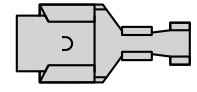
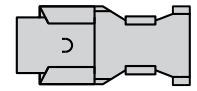

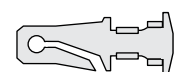
Mopar B-body
REAR BODY KIT

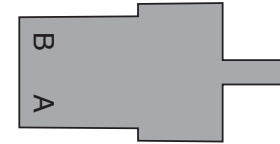
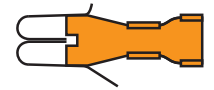
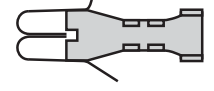
510639

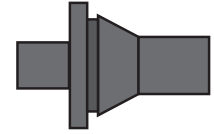
Classic Update Series

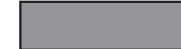
- A  LH Turn Socket & Pigtail (2 pcs)
- B  RH Turn Socket & Pigtail (2 pcs)
- C  LH Turn Socket & Pigtail (2 pcs)
- D  RH Turn Socket & Pigtail (2 pcs)
- G  Back-up Light Socket & Pigtails (2 pcs)
- H  Running Light Socket & Pigtail (2 pcs)

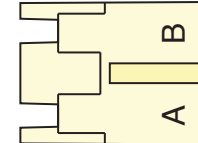
- J  Dome Light Socket & Pigtail (1 pc)
- K  Fuel Tank Connector (1 pc)
- L  Side Marker Light Extensions (2 pcs)
- M  Ground Jumpers (2 pcs)
- N  (56 Series 3-way female connector, 4 pcs)
- P  (56 Series 2-way female connector, 2 pcs)
- Q  (56 Series single female connector, 1 pc)
- R  (56 Series single female terminal, 8 pcs)
- S  (56 Series double female terminal, 17 pcs)
- U  (56 Series single male connector, 1 pc)
- V  (56 Series single male terminal, 2 pcs)

- X  (Pack Con 2-way female connector, 2 pcs)
- Y  (Pack Con single female terminal, 5 pcs)
- Z  (Pack Con double female terminal, 5 pcs)
- AA  (grommet, 3/4" hole, 2 pcs)
- BB  (grommet, 1/2" hole, 1 pc)
- CC  (Single male bullet terminal, 9 pcs)
- DD  (Single female bullet terminal, 9 pcs)
- EE  (Large rubber sleeve, 9 pcs)
- FF  (Small rubber sleeve, 9 pcs)
- GG  (grommet, 7/8" hole, 1 pc)
- HH  (Pack Con 2-way male connector, 1 pc)
- JJ  (Pack Con single male terminal, 3 pcs)

1968-70

Mopar B-body
REAR BODY KIT

510639

92971543 Rev 0.0 4/29/2016

Classic Update Series

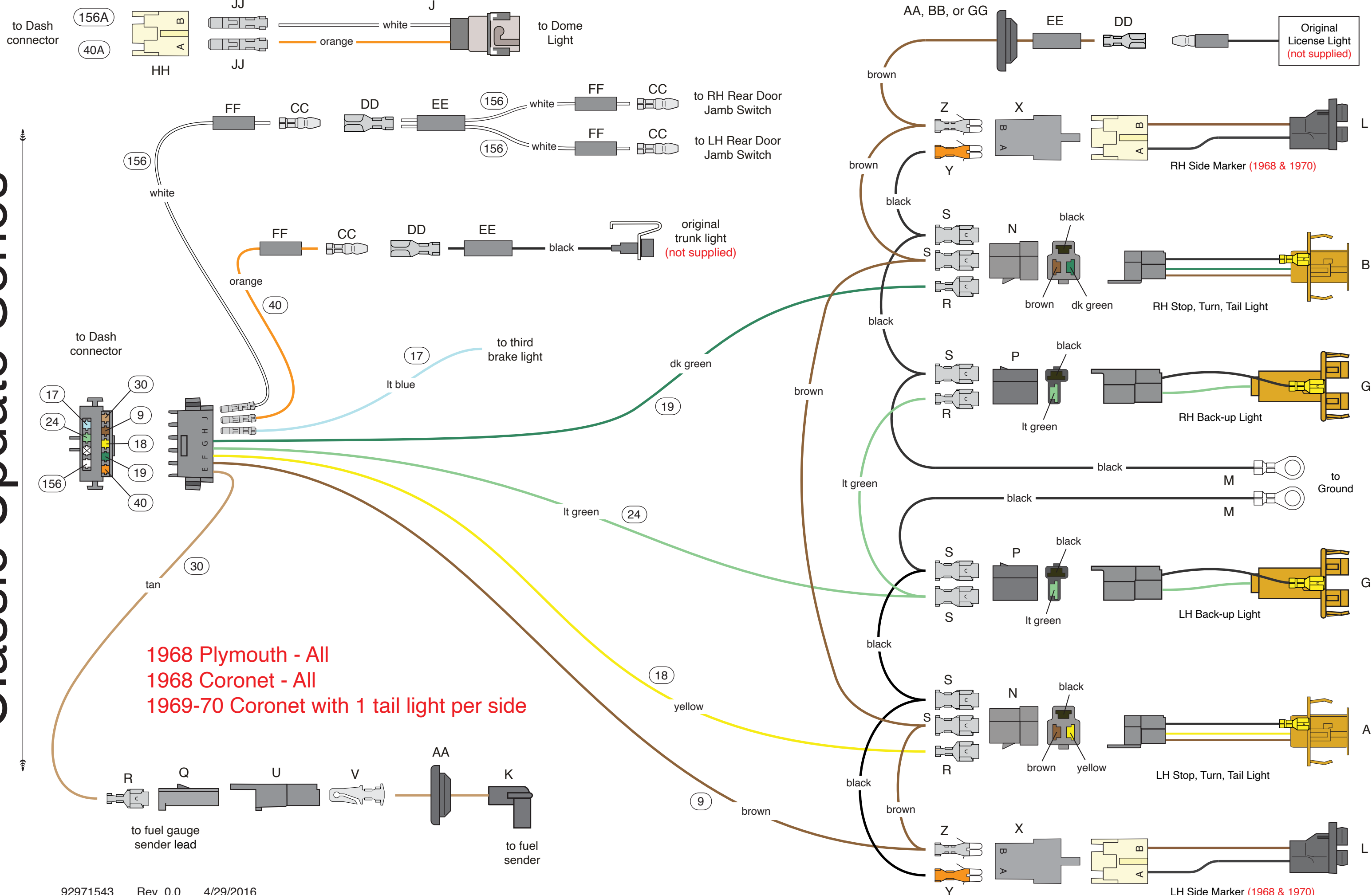

**1968 Plymouth - All
1968 Coronet - All
1969-70 Coronet with 1 tail light per side**

**Original License Light
(not supplied)**

**original trunk light
(not supplied)**

RH Side Marker (1968 & 1970)

RH Stop, Turn, Tail Light

RH Back-up Light

LH Back-up Light

LH Stop, Turn, Tail Light

LH Side Marker (1968 & 1970)

Classic Update Series

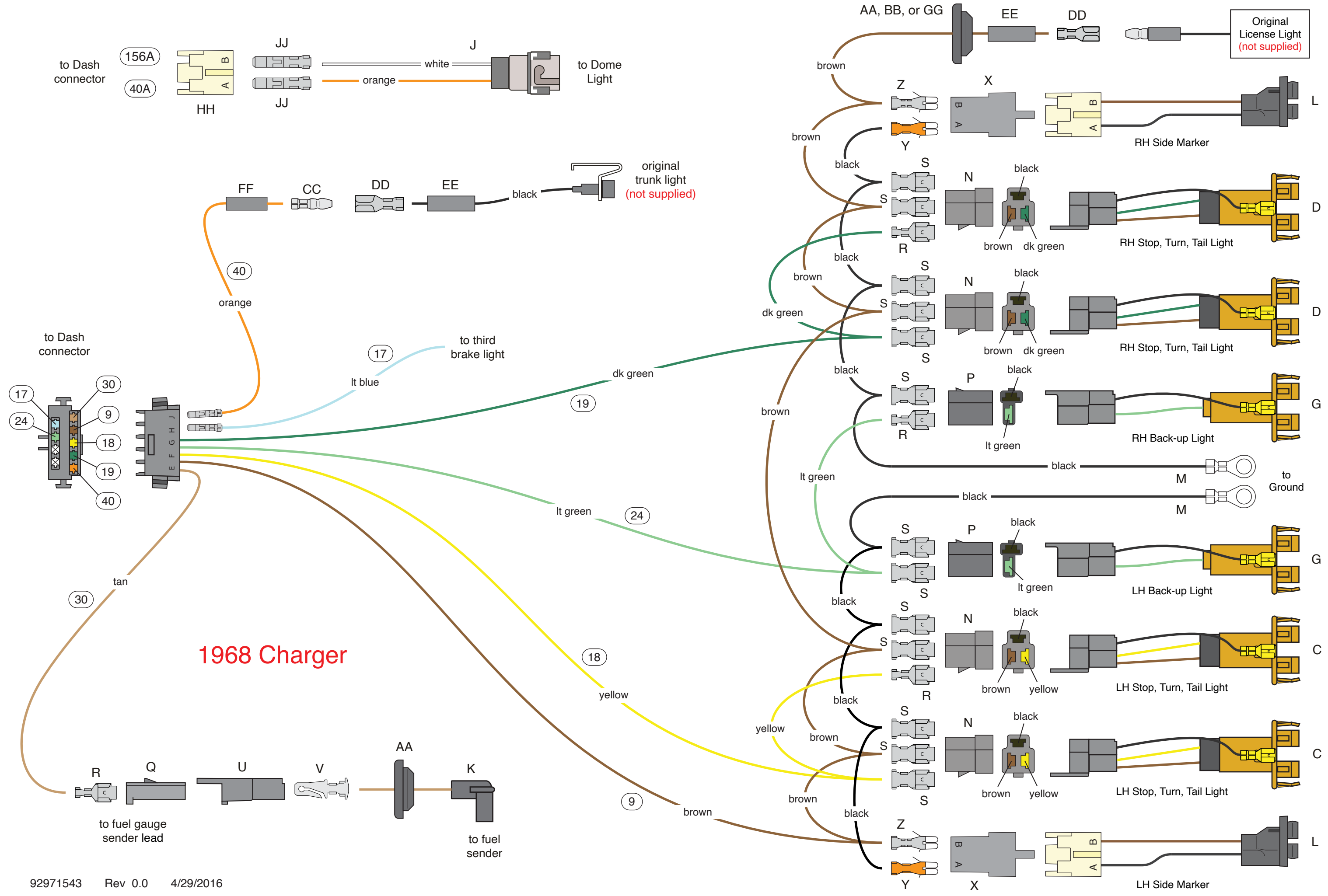

Classic Update Series

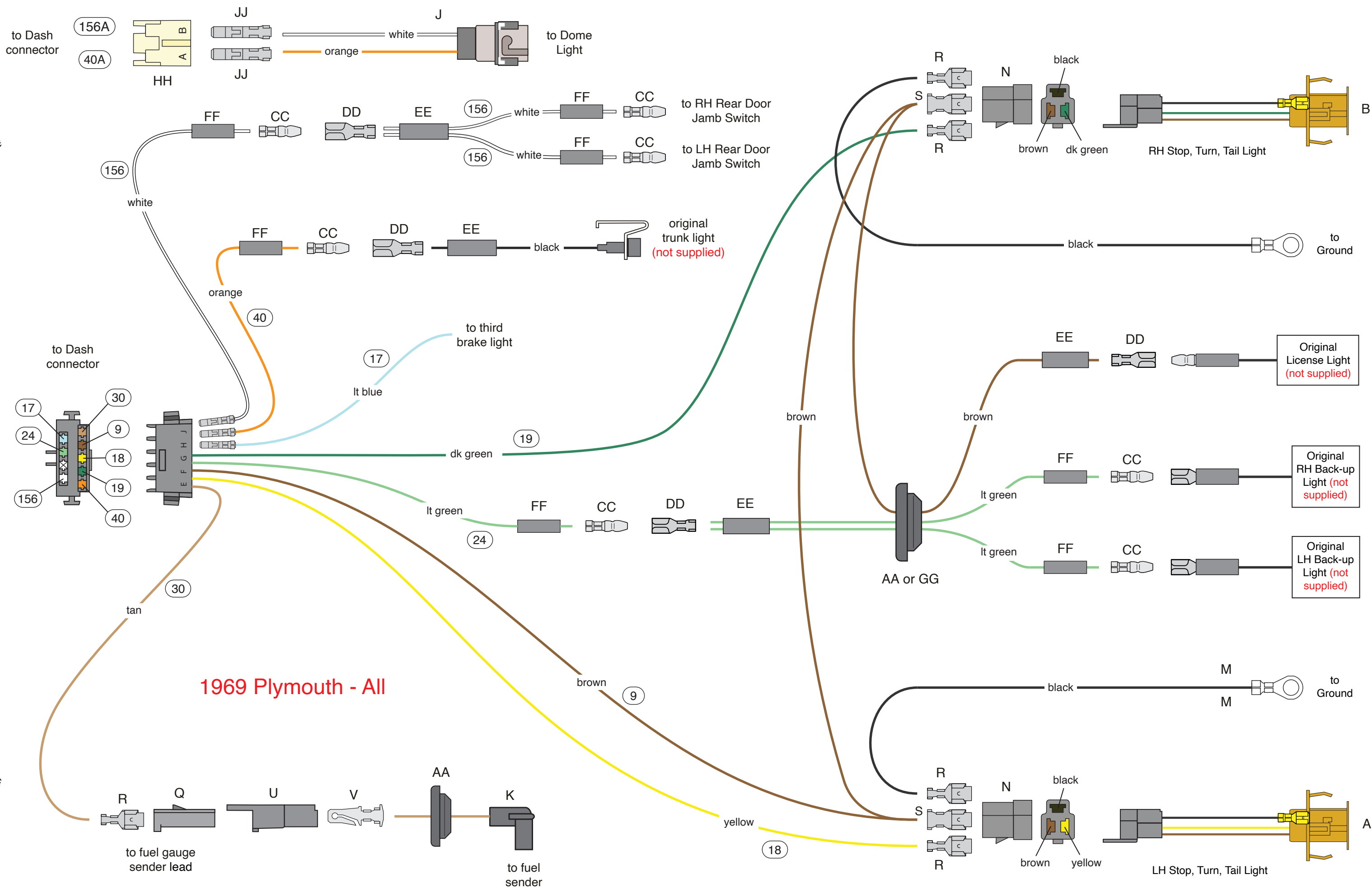

1969 Plymouth - All

Classic Update Series

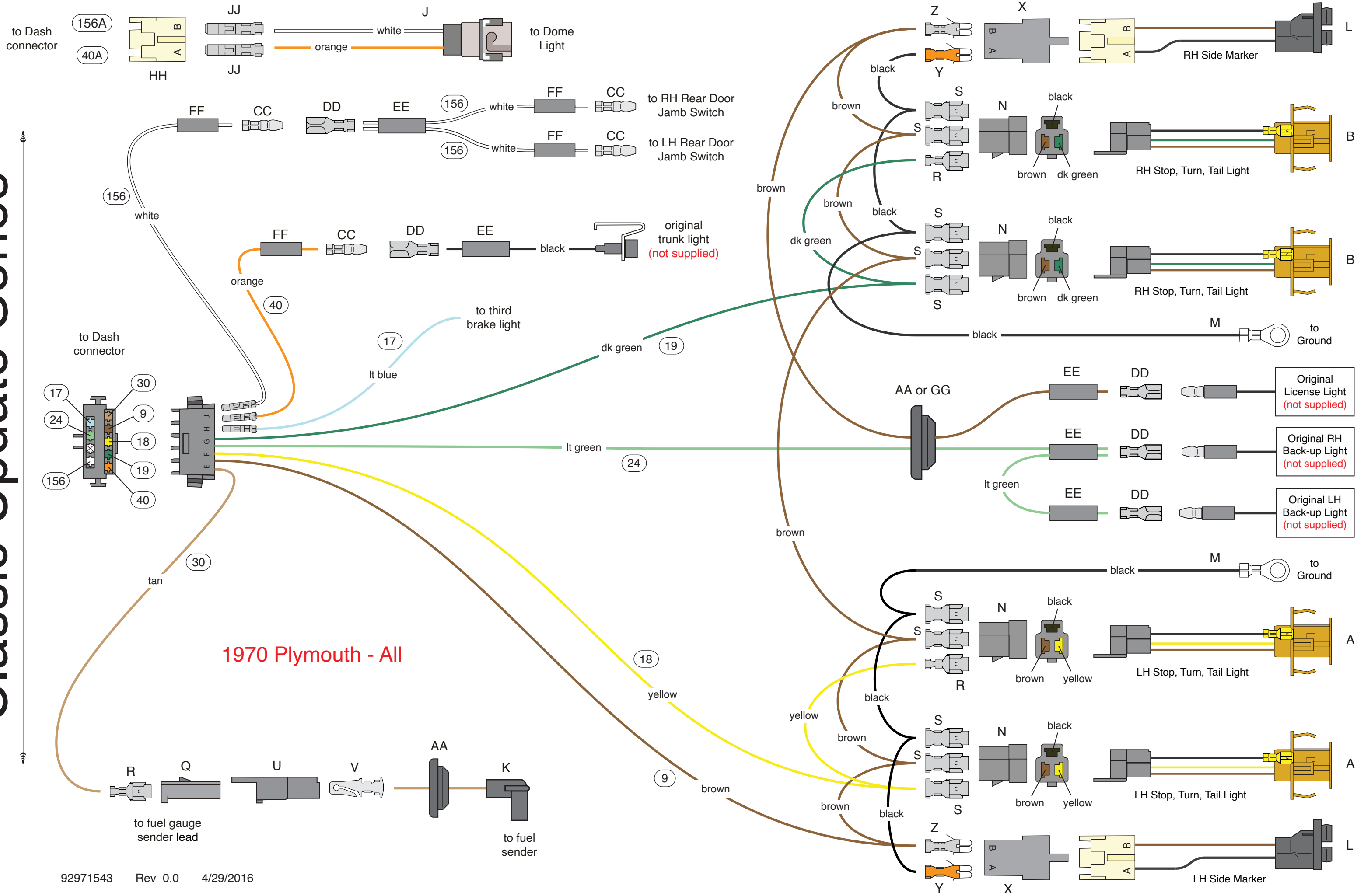

Classic Update Series

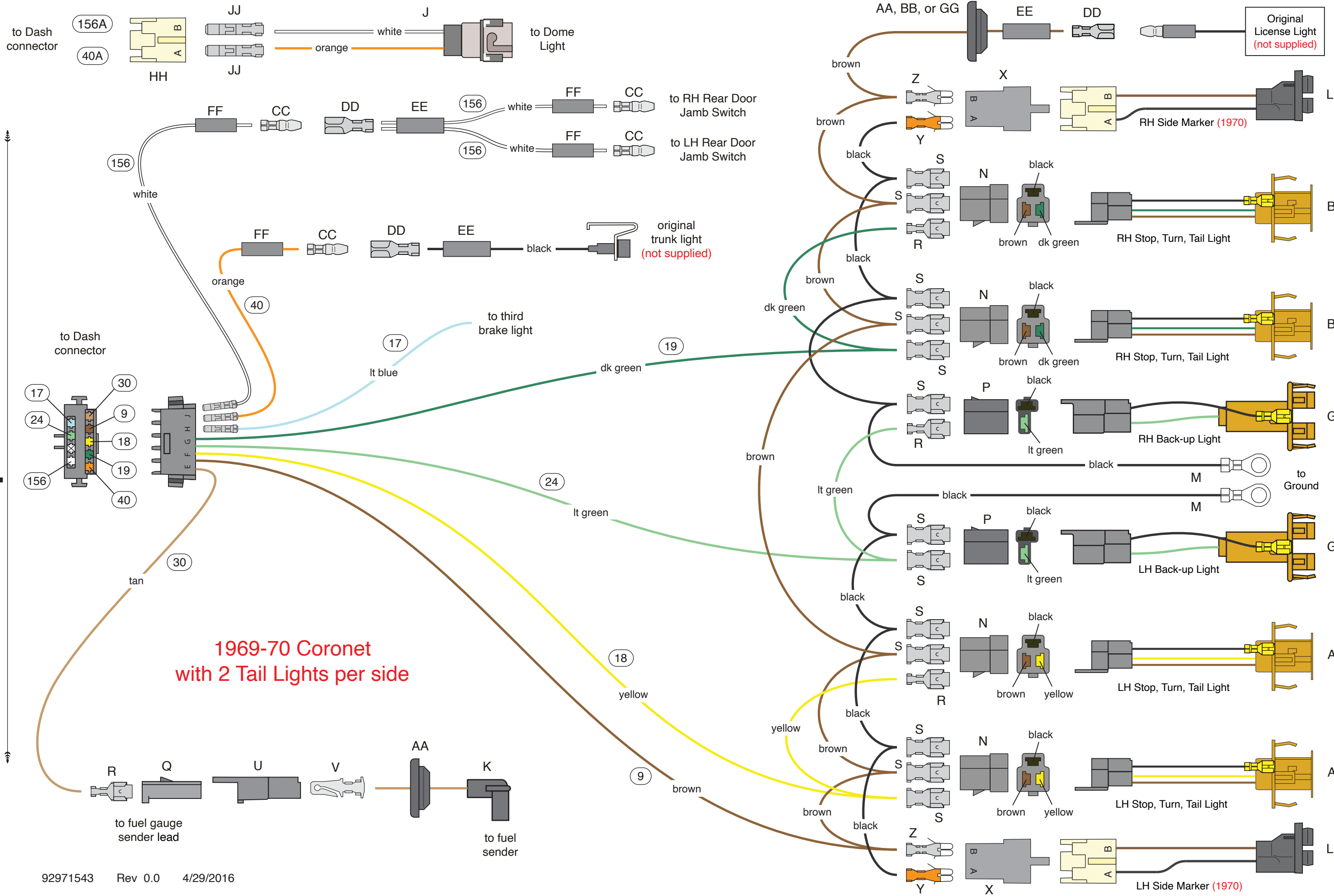

Classic Update Series

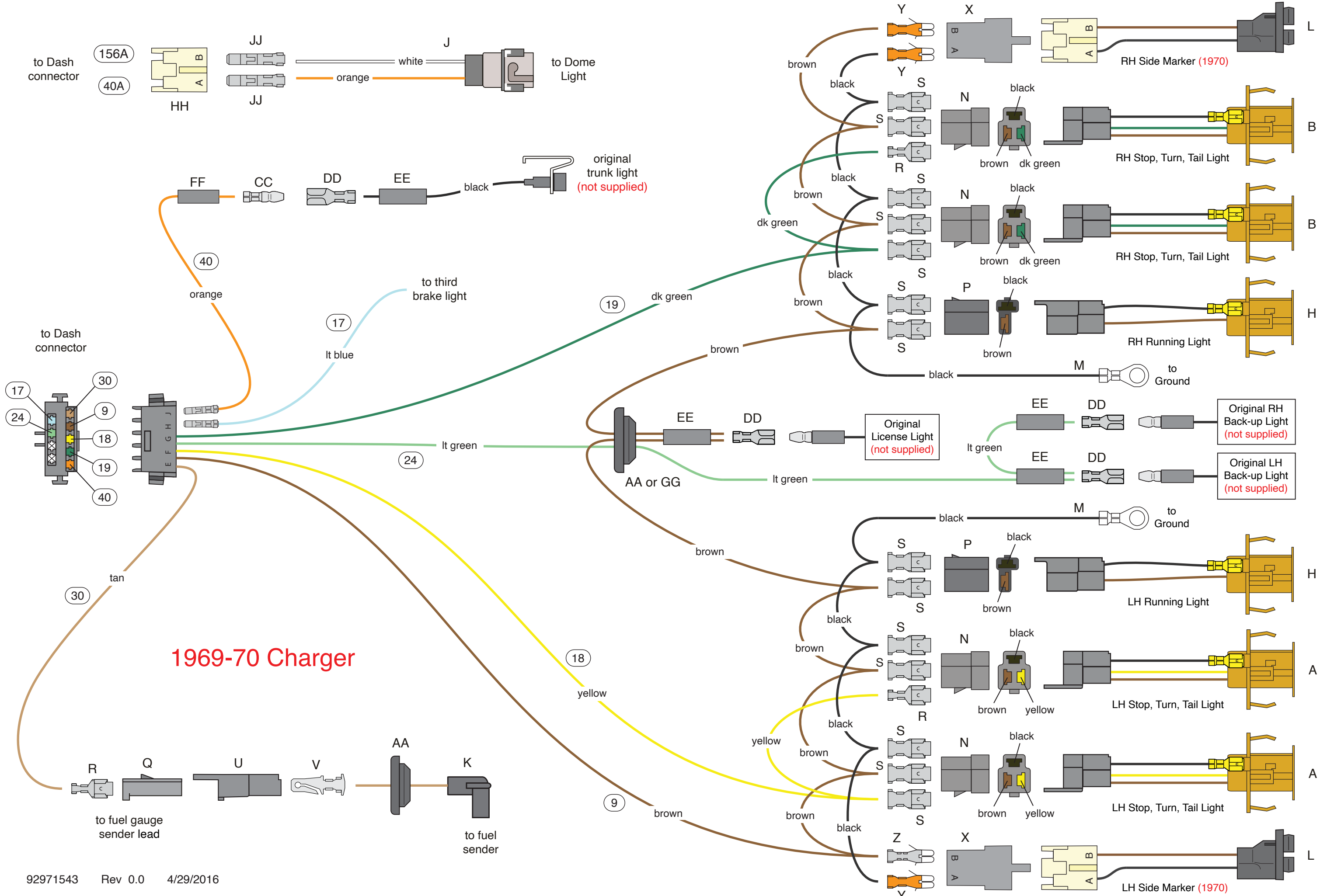

THIS PAGE INTENTIONALLY
LEFT BLANK

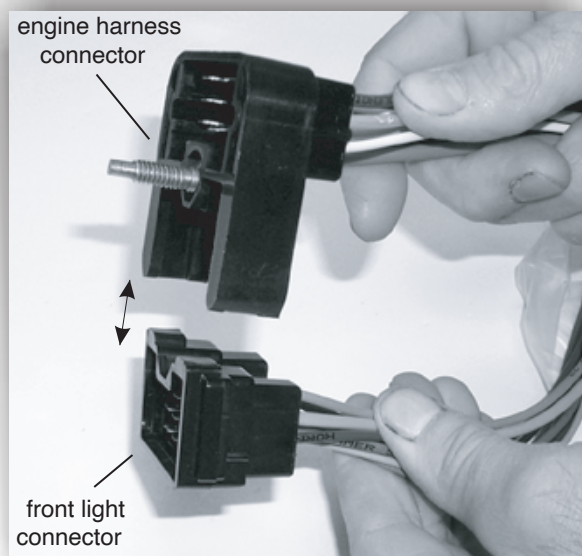

apply silicone sealant to back side of connector after installing terminals

The bulkhead connector from this front light kit must snap into the mating engine connector (bag J), as shown. After snapping together, bolt the assembly into the dash harness firewall connector using the attached bolt.

OPTIONAL Add-On Equipment:

Look!



American Autowire also sells factory OEM style harness wrap. This is the same tape used on original Chrysler harnesses! If you want that OEM look with your Classic Update wiring system, then give us a call and order p/n R0067108 !



500093
Weatherproof
Universal
Relay Kit



500479
Universal
Relay Kit

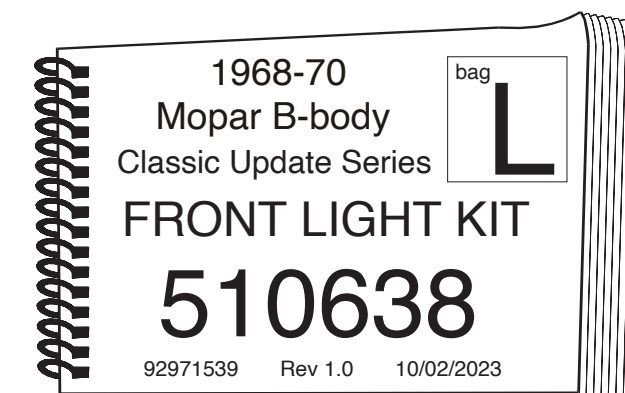

Optional Wire to be plugged into the Bulkhead Connector

If you will be installing an optional Electric Fan in your Engine Compartment, plug the loose orange “ELECTRIC FAN” wire (circuit 300) into your 14-way Bulkhead Connector (see page 5).

Temporarily plug the Front Light Harness 14-way Bulkhead Connector into the mating Bulkhead Connector of the Dash Harness (located in the center of the Firewall) before routing and connecting any of the wires. The Front Light Harness Bulkhead Connector will need to be removed from the Dash Harness Bulkhead Connector later after routing and attaching all of the wires and will be snapped into the Engine Harness Bulkhead Connector (see page 1).

Preparing the Parking Light Assemblies

Park/Turn Light Socket and Pigtail Assemblies

For all vehicles you will use your original Park/Turn Light Socket and Pigtail Assemblies but will have to replace the original 2-way molded pigtail connector (see page 5) with a 2-way connector “H” and terminals “J” from the Loose Parts Kit 92971540. Cut the original connector from the pigtail and crimp on a terminal “J” to each wire. Plug these wires into connector “H” (see page 5). Note that the wire function/colors/ are as follows:

Turn Signal - black/green (Mopar) to blue (AAW),
 Park Lights - black/yellow (Mopar) to brown (AAW),

Side Marker Light Socket and Pigtail Assemblies

For the 1968 and 1970 vehicles you will replace your original Side Marker Assembly with the Side Marker Assembly Pigtail “R”.

Standard Wires already plugged into the Bulkhead Connector

1. Wiper Motor

These four wires (brown, red, dark green, dark blue) come from the Front Light Bulkhead connector and are already plugged into a 4-way connector in your Front Light Harness (see page 5). This 4-way connector will connect to the Wiper Motor pigtail. Obtain the 4-way mating connector “N” and four terminals “D” in the Loose Piece Kit 92971540. Cut the four Wiper Motor wires (brown, red, dark green and dark blue) from the original Wiper Motor pigtail 8-way connector. Note that these wires are all next to each other on one side of the 8-way connector and that there may be extra wires in the 8-way connector, but these will not be used. Crimp on terminal “D” to each of the four wires and plug into connector “N”. Maintain color continuity (brown to brown, blue to blue, red to red and green to green) when you plug the wires in connector “N”. The 2-speed Wiper Motors have a Jumper Harness attached (available from the Aftermarket) and the 3-speed Wiper Motors have a pigtail. See pages 5 and 6 for more detail.

2. Brake Warning Switch

This tan “BRAKE LIGHTS/SWITCH” wire (circuit 33) comes from the Bulkhead Connector and has a molded 1-way right angle black connector at the other end. Route this wire to your Brake Warning Switch, which is attached to your Brake Pressure Differential Switch, and plug the molded connector to the switch.

Wire Color	Printing	Wire Number
Tan	BRAKE LIGHTS/SWITCH	33

Park/Turn Light Connections

3. Park Light/Side Marker Light Wire Connections

For the left hand (LH) Park Light/Side Marker Light connections obtain the shorter brown “PARK LIGHTS” wire (circuit 9A) from the Front Light Harness and route the loose end of this wire to the left Park/Turn Signal Light pigtail and cut to length. Crimp on terminal “D”, and plug into the 2-way connector “F”. If you have a Side Marker Light, double this brown wire with the cutoff portion, crimp on terminal “E” and plug into connector “F”. Route the loose end to the LH Side Marker Light and cut to length, crimp on terminal “Q” and plug into the 2-way connector “P” (as shown on page 5).

For the right hand (RH) Park Light/Side Marker Light connections repeat the process with the longer brown “PARK LIGHTS” wire (circuit 9B).

Wire Color	Printing	Wire Number
Brown	PARK LIGHTS	9A (shorter wire)
Brown	PARK LIGHTS	9B (longer wire)

4. LH Turn Light Wire Connections

With Hood Mounted Turn Signal Indicators

Obtain the light blue “LEFT FRONT TURN” wire (circuit 14) and route the loose end of the wire to the original Hood Light Harness 2-way connector. Cut to length and double this wire with the light blue wire that was just cut. Crimp on female terminal “E” and plug into connector “F” (as shown on page 5). Continue routing the light blue wire to the LH Park/Turn Signal Light pigtail and cut to length. Crimp on terminal “D” and plug into the 2-way connector “F”.

With Fender Mounted Turn Signal Indicators

Obtain the light blue “LEFT FRONT TURN” wire (circuit 14) and route the loose end of the wire to the LH Park/Turn Signal Light pigtail and cut to length, double this light blue wire with the cutoff portion, crimp on terminal “E” and insert into connector “F”. Route the loose end of the light blue wire to the LH Fender Mounted Turn Signal Indicator pigtail and cut to length, slide on sleeve “L”, and crimp on terminal “K”.

Without Hood or Fender Mounted Turn Signal Indicators.

Obtain the light blue “LEFT FRONT TURN” wire (circuit 14) and route the loose end of the wire to the LH Park/Turn Signal Light pigtail and cut to length, crimp on terminal “E” and insert into connector “F”.

Wire Color	Printing	Wire Number
Light Blue	LEFT FRONT TURN	14

5. RH Turn Light Wire Connections

With Hood Mounted Turn Signal Indicators

Obtain the dark blue "RIGHT FRONT TURN" wire (circuit 15) and route the loose end of the wire to the original Hood Light Harness 2-way connector. Cut to length and double this wire with the dark blue wire that was just cut. Crimp on female terminal "E" and plug into connector "F" (as shown on page 5). Continue routing the dark blue wire to the RH Park/Turn Signal Light pigtail and cut to length. Crimp on terminal "D" and plug into the 2-way connector "F".

With Fender Mounted Turn Signal Indicators

Obtain the dark blue "RIGHT FRONT TURN" wire (circuit 15) and route the loose end of the wire to the RH Park/Turn Signal Light pigtail and cut to length, double this dark blue wire with the cutoff portion, crimp on terminal "E" and insert into connector "F". Route the loose end of the dark blue wire to the RH Fender Mounted Turn Signal Indicator pigtail and cut to length, slide on sleeve "L", and crimp on terminal "K".

Without Hood or Fender Mounted Turn Signal Indicators.

Obtain the dark blue "RIGHT FRONT TURN" wire (circuit 15) and route the loose end of the wire to the RH Park/Turn Signal Light pigtail and cut to length, crimp on terminal "E" and insert into connector "F".

Wire Color	Printing	Wire Number
Dark Blue	RIGHT FRONT TURN	15

Front Headlamp Connections

6. Low Beam Headlight Wire Connections

Obtain the tan "HEADLIGHT-LOW BEAM" wire (circuit 12) and route the loose end of the wire to the LH Low Beam Headlamp (see page 5), cut to length, double with the wire that was just cut off, crimp on the large terminal "B", and insert into the Low Beam Headlight Pigtail "A" from Loose Parts Kit 92971540. Route the loose tan wire to the RH Low Beam Headlamp, cut to length, crimp on the large terminal "C" and insert into the other Low Beam Headlight Pigtail "A".

Wire Color	Printing	Wire Number
Tan	HEADLIGHT-LOW BEAM	12

7. High Beam Headlight Wire Connections

Obtain the light green "HEADLIGHT-HI BEAM" wire (circuit 11) and route the loose end of the wire to the LH Low Beam Headlamp (see page 5), cut to length, double with the wire that was just cut off, crimp on the large terminal "B", and insert into the Low Beam Headlight Pigtail "A" from the Loose Parts Kit 92971540. Route the loose light green wire to the LH High Beam Headlight, cut to length, double with the wire that was just cut off, crimp on terminal "B" and insert into the LH High Beam Headlight 2-way connector "G". Route the light green wire to the RH side and repeat the process for the RH High and Low Beam Headlights. When there is only one wire in the terminal, you will crimp on terminal "C".

Wire Color	Printing	Wire Number
Light Green	HEADLIGHT-HI BEAM	11

8. Ground Wire Connections

Each Low Beam Headlight Pigtail "A", has a black "GROUND" wire (circuits 150A and 150B) with a ground ring terminal and also has an un-terminated ground wire (circuits 150C and 150D) doubled with 150A and 150B wires in each 3-way Head Light connector (see page 5). Locate a good ground location for each ring terminal and attach each ring terminal to a good ground. Obtain the un-terminated black wire and route the loose end of this wire to the 2-way High Beam Headlight Connector "G", cut to length, double with the cut off portion, crimp on terminal "B" and plug terminal "B" into Connector "G". Route the cutoff portion to the Side Marker Assembly (1968 and 1970 only), cut to length, crimp on terminal "Q" and plug into the 2-way Side Marker connector "P". Repeat the process for the opposite side.

Wire Color	Printing	Wire Number
Black	GROUND	150A
Black	GROUND	150B
Black	GROUND	150C
Black	GROUND	150D

Horn Wire Connections

9. Horn Wire Connections

Obtain the dark green "HORN" wire (circuit 29) and route the loose end of the wire along with the Front Lighting wires to the Horns, cut to length, double this dark green wire with the cutoff portion, crimp on terminal "E" and plug into connector "M". Connect to the first Horn. Route the loose end of the dark green wire to the second Horn and cut to length, crimp on terminal "D" and plug into connector "M". You can now connect this to the second Horn.

Wire Color	Printing	Wire Number
Dark Green	HORN	29

Washer Pump Connection

10. Washer Pump Connection

Obtain the tan no printing wire (circuit 94) and route it with the Front Light wires to the Electric Washer Pump. This wire is the feed wire for the Electric Washer Pump.

Wire Color	Printing	Wire Number
Tan	no printing	94

Electric Fan Connection

11. Electric Fan (optional)

If you haven't already, obtain the orange "ELECTRIC FAN" wire (circuit 300) and plug it into the Bulkhead connector (as shown on page 5). This wire is a 12V Accessory feed wire which comes directly from the Fuse Block and is intended to be used as the relay trigger wire for the Electric Fan Relay. Route this wire to a relay kit.

Note: An Optional Relay Kit (Universal Relay Kit 500479 or Universal Waterproof Relay Kit 500093) can be purchased from AAW. Connect per the instructions in the Relay Kit.

Wire Color	Printing	Wire Number
Orange	ELECTRIC FAN	300

Classic Update Series

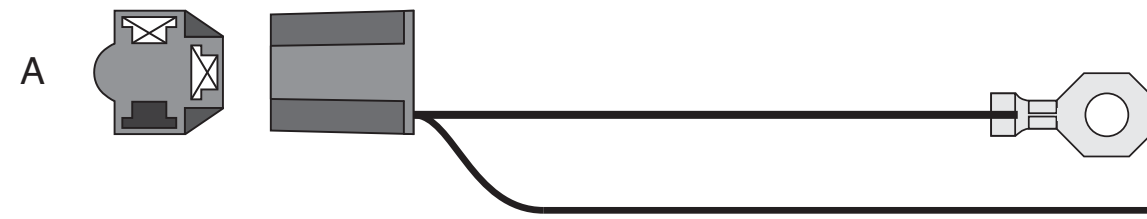

Headlight Pigtail (2 pcs)

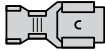
B  (59 Series double female terminal, 10 pcs)

C  (59 Series single female terminal, 6 pcs)

D  (56 Series single female terminal, 12 pcs)

E  (56 Series double female terminal, 9 pcs)

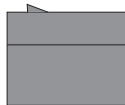
F  (56 Series 2-way female connector, 3 pcs)

G  (59 Series 2-way female connector, 2 pcs)

H  (56 Series 2-way male connector, 2 pcs)

J  (56 Series single male terminal, 6 pcs)

K  Single female bullet terminal, 4 pcs)

L  Large rubber sleeve, 4 pcs)

M  (56 Series 1-way female connector, 2 pcs)

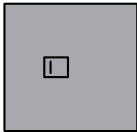
N  (56 Series 4-way female connector, 1 pc)

P  (Pack Con 2-way female connector, 2 pcs)

Q  (Pack Con single female terminal, 6 pcs)

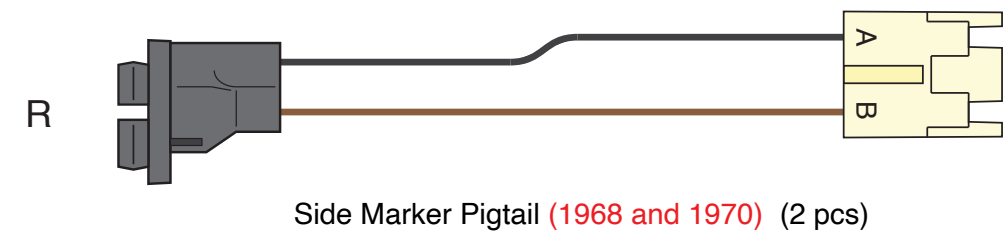

Side Marker Pigtail (1968 and 1970) (2 pcs)

Classic Update Series

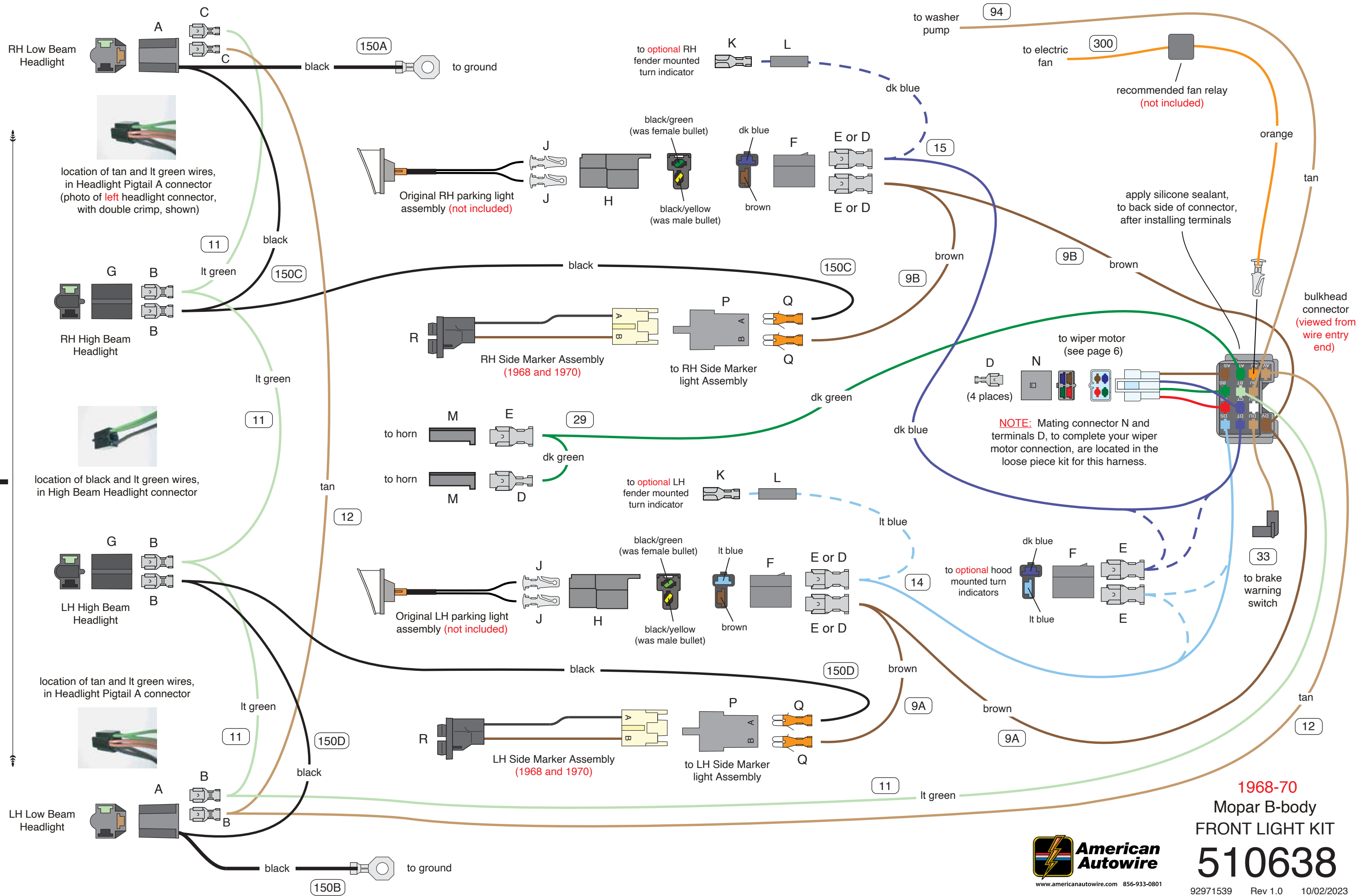

Wiper motor instructions

2-speed wiper motor wiring:

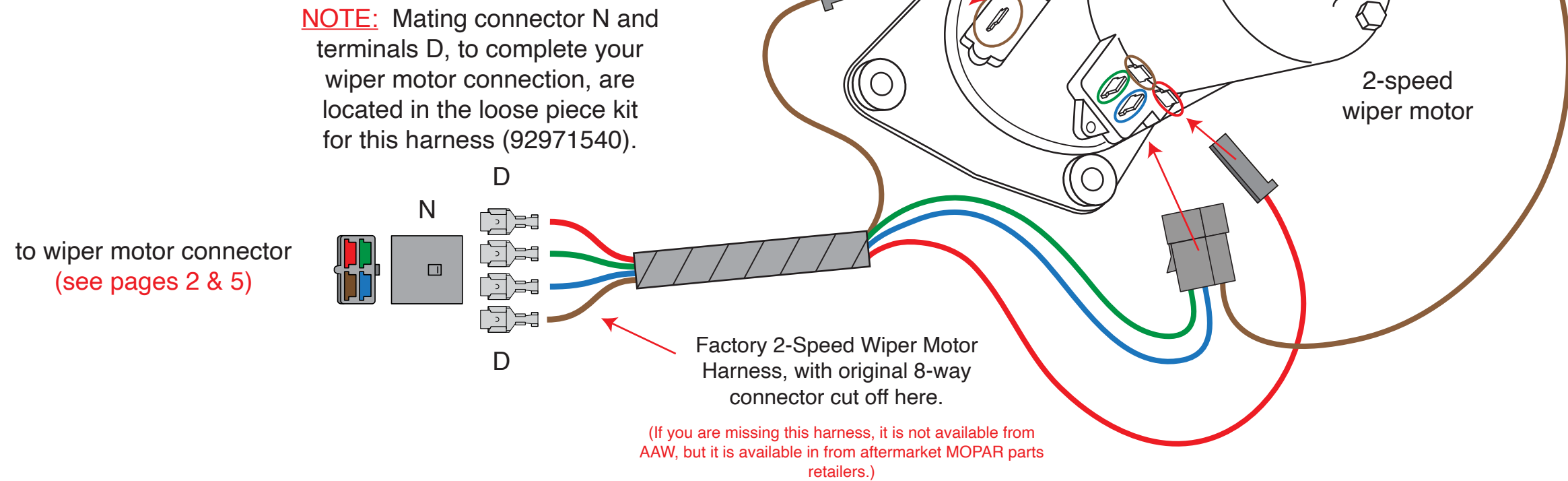

Wiper motor instructions

3-speed wiper motor wiring:

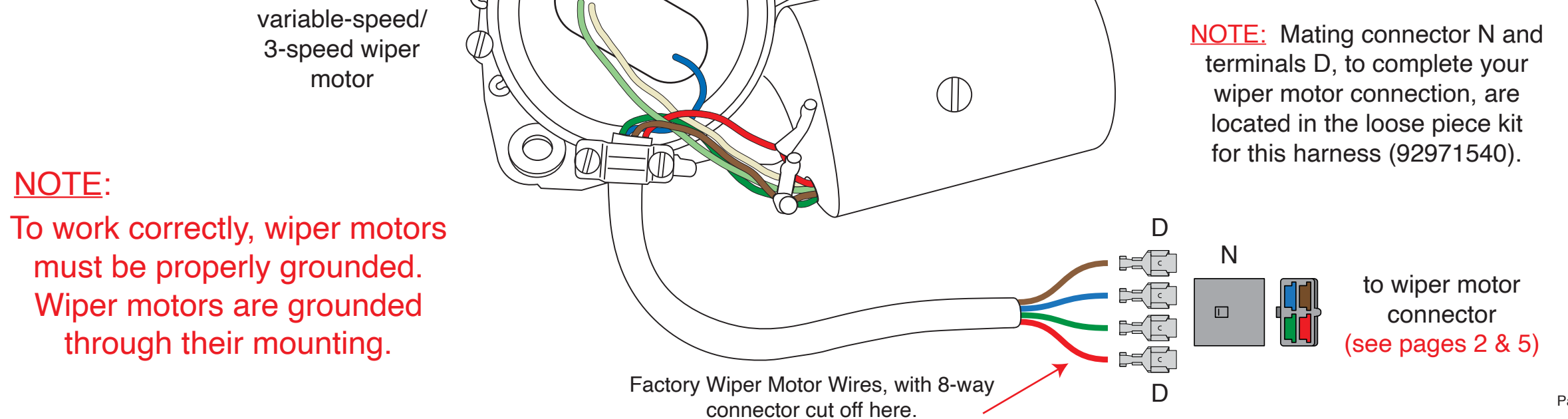

www.americanautowire.com 856-933-0801

1968-70 MOPAR B-Body
FRONT LIGHT KIT
Classic Update Series

510638 92971539 Rev 1.0 10/02/2023

(MEGA-FUSES, BOOT, RING TERMINALS AND SHRINK TUBING FOUND IN 510476 KIT)

6 GA. RED (FROM 510476 KIT)

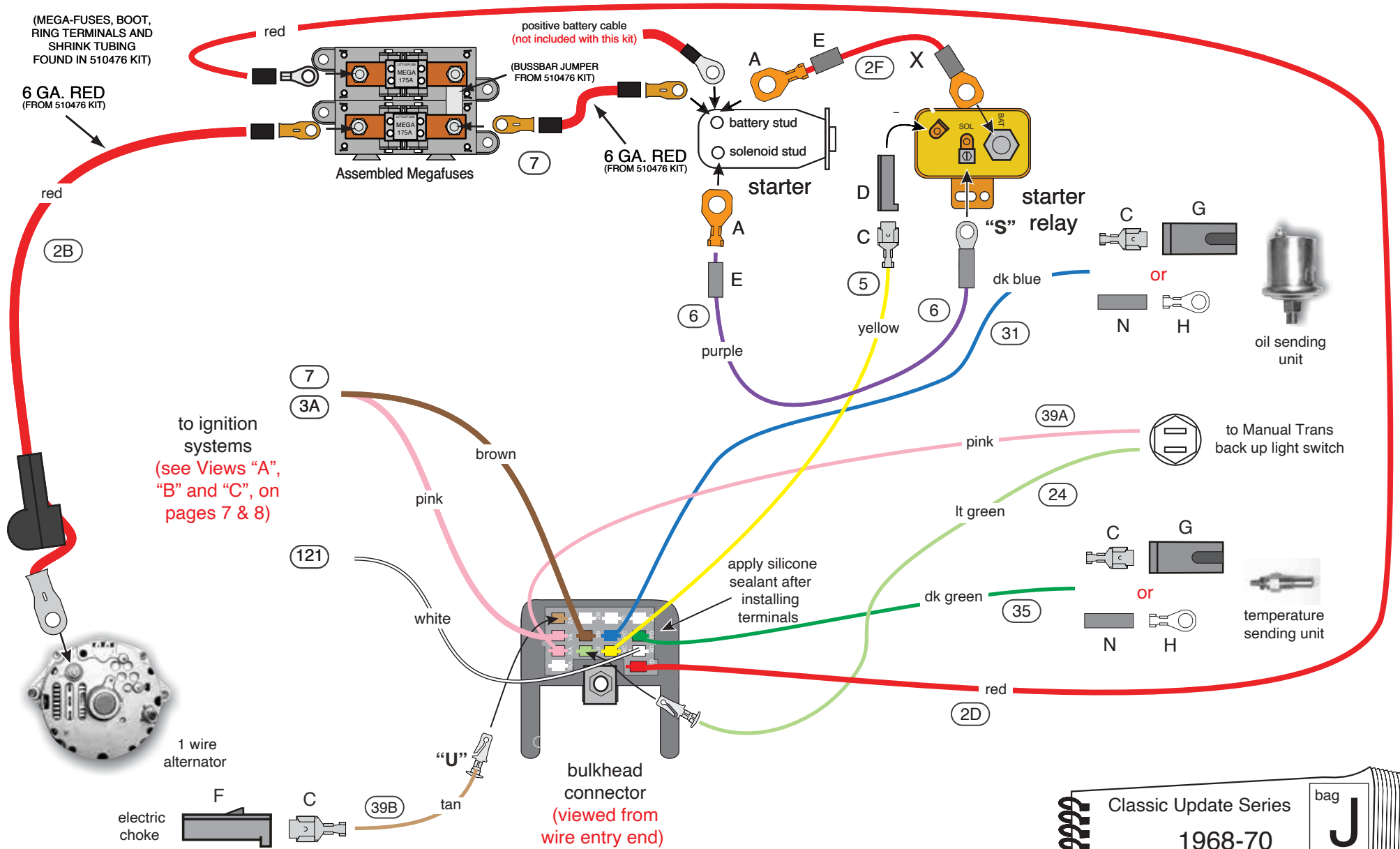

Classic Update Series bag J

1968-70

Mopar B-body

ENGINE KIT

510783

92972813 Rev 1.0 10/19/2023

(MEGA-FUSES, BOOT, RING TERMINALS AND SHRINK TUBING FOUND IN 510476 KIT)

6 GA. RED (FROM 510476 KIT)

red

(2B)

to ignition systems
(see Views "A", "B" and "C", on pages 7 & 8)

1 wire alternator

electric choke

F

C

(39B)

"U"

tan

bulkhead connector
(viewed from wire entry end)

apply silicone sealant after installing terminals

(2D)

red

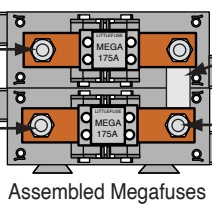

(BUSSBAR JUMPER FROM 510476 KIT)

6 GA. RED (FROM 510476 KIT)

starter

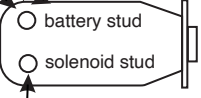

A

E

(6)

purple

(5)

yellow

"Q"

(31)

dk blue

(39A)

pink

(121)

white

dk green

(155)

black

lt green

(24)

(35)

red

E

(2F)

X

battery stud

solenoid stud

D

C

(6)

"S"

(31)

dk blue

(39A)

pink

(121)

white

dk green

(155)

black

lt green

(24)

(35)

red

(2D)

red



starter relay

C

G

or

N

H



oil sending unit



to Manual Trans back up light switch

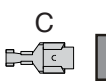

temperature sending unit

Classic Update Series

1968-70

Mopar B-body

ENGINE KIT

510783

92972813

Rev 1.0

10/19/2023

bag

J



American Autowire

www.americanautowire.com 856-933-0801

(MEGA-FUSES, BOOT, RING TERMINALS AND SHRINK TUBING FOUND IN 510476 KIT)

6 GA. RED (FROM 510476 KIT)

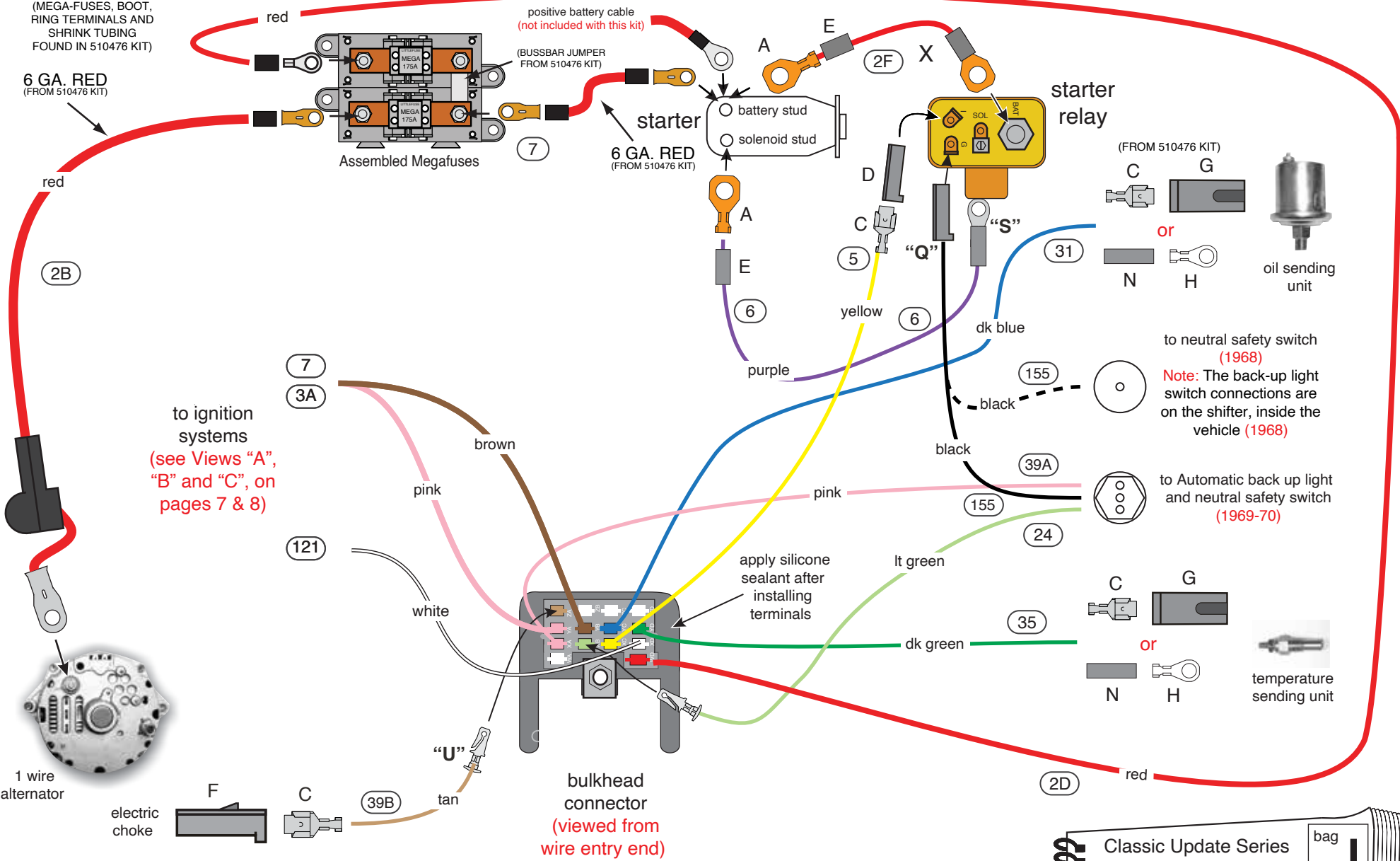

Classic Update Series bag J

1968-70
Mopar B-body
ENGINE KIT
510783

92972813 Rev 1.0 10/19/2023



**American
Autowire**

www.americanautowire.com 856-933-0801

Optional Wires to be plugged into the Bulkhead Connector

If you have any of the following, plug these wires into the Engine Harness 14-way Bulkhead Connector (see pages 1-3) first: Electric Choke, plug in the loose tan "ELECTRIC CHOKE" wire (circuit 39B).

Temporarily plug the Engine Harness 14-way Bulkhead Connector into the mating Bulkhead Connector of the Dash Harness (located in the center of the Firewall) before routing and connecting any of the wires. The Engine Harness Bulkhead Connector will need to be removed from the Dash Harness Bulkhead Connector later after routing and attaching all of the wires, and will be snapped into the Front Light Harness Bulkhead Connector.

1. Back-up Lights – Manual Transmission

For the 1968–1970 vehicles, the Back-up Switch is located on the Transmission. Plug the light green wire (circuit 24) into the bulkhead connector in the location shown on pages 1 and 2. Obtain the thin pink "12V IGNITION" wire (circuit 39A) and the light green "BACK UP LT SW --> LIGHTS" wire (circuit 24) from the 14-way Bulkhead Connector in the Engine Harness **510638 Bag J**, and route these wires to the Back-up Light Switch (see pages 1 and 2).

Wire Color	Printing	Wire Number
Pink	12V IGNITION	39A
Light Green	BACK UP LT SW --> LIGHTS	24

2. Backup Lights/Neutral Safety Switch – Automatic Transmission

For the 1968 vehicles, the Back-up Light Switch is located inside the vehicle on the Shifter (see the Dash Harness Instructions for this connection). Since the pink and light green Back-up Switch wires are in the Dash Harness as well as the Engine Harness, you will not use the pink (circuit 39A) and light green (circuit 24) wires in the Engine Kit. Remove these two wires from the bulkhead connector and stow them away. The Neutral Safety Switch is located on the Transmission and it is a single pin switch. Obtain Pigtail "Q" with the black, no printing wire, (circuit 155) and plug the connector of pigtail "Q" to the Starter Relay Ground Terminal **G** (see page 3). This wire will provide ground for the Starter Relay during crank. Route the black wire to the Neutral Safety Switch on the transmission and connect.

For the 1969-1970 vehicles, the Back-up Light Switch and the Neutral Safety Switch are combined into one 3-pin Switch which is located on the transmission. Plug the light green wire (circuit 24) into the bulkhead connector in the location shown on page 3. Obtain the thin pink "12V IGNITION" wire (circuit 39A) and the light green "BACK UP LT SW --> LIGHTS" wire (circuit 24) from the 14-way Bulkhead Connector in the Engine Harness and route these wires to the 3-pin Back-up Light Switch (see page 3) and cut to length.

Obtain Pigtail "Q" with the black no printing wire (circuit 155) and plug the connector of pigtail "Q" to the Starter Relay Ground Terminal **G** (see page 3). This wire will provide ground for the Starter Relay during crank. The center pin of the 3-pin Backup Light/Neutral Safety Switch goes to ground in Park or Neutral. Route the loose end of the black wire to the 3-pin Backup Light/Neutral Safety Switch on the Automatic Transmission and cut to length. Obtain a 3-wire Aftermarket Jumper Harness available for this 3-pin Backup Light/Neutral Safety Switch, crimp on three terminal "J's" to each wire of the Jumper Harness and insert each terminal into a 1-way connector "P". Crimp on terminals "C" to the light green (circuit 24), black (circuit 155), and pink (circuit 39A) wires from the Engine Kit and insert each into a 1-way connector "F". Now connect all three connectors "F" to the Jumper Harness. **Note: the black wire (circuit 155) from the Engine Kit must be connected to the center pin (brown wire) of the Backup Light Switch. Connect the light green wire (circuit 24) to the black wire and connect the pink wire (circuit 39A) to the purple wire of the Aftermarket Jumper Harness. Polarity doesn't matter for the outer two pins.**

Wire Color	Printing	Wire Number
Pink	12V IGNITION	39A
Light Green	BACK UP LT SW --> LIGHTS	24
Black	no printing	155

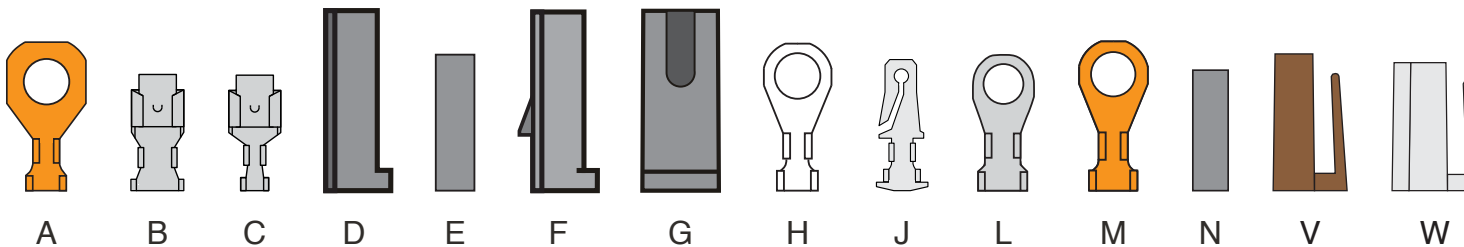

ENGINE KIT
510783

3. Clutch Interlock Switch

For the 1970 vehicles with a Manual Transmission, The Clutch must be depressed before you can crank the Engine. To accomplish this, the ground terminal **G** on the Starter Relay goes to ground through a wire that connects to a Clutch Interlock Switch on the Clutch Pedal. Obtain the pigtail “**Q**” with the black no printing wire (circuit 155) and connect the 1-way connector of this pigtail to the ground terminal **G** of the Starter Relay (see page 2). Route the black wire to the Engine Bulkhead Connector and cut to length. Crimp on terminal “**J**” and plug into the Bulkhead Connector (unplug the Bulkhead connectors to plug in terminal “**J**” and then make sure that terminal “**J**” is fully seated and then, reconnect the Bulkhead Connectors).

Note: for the 1968-69 vehicles with a Manual Transmission, there is a unique Starter Relay that does not have a ground terminal on the relay and there is no Clutch Interlock Switch on the Clutch Pedal. Pigtail “**Q**” will not be used for these vehicles (see Page 1).

<u>Wire Color</u>	<u>Printing</u>	<u>Wire Number</u>
Black	no printing	155

4. Main Fuse Panel Feed

Obtain the large red “12V BATTERY” wire (circuit 2D. This wire is already plugged into the Bulkhead Connector) and route to the MegaFuse supplied with the 510476 kit, cut to length, install ring terminal and shrink tube. Connect as shown. (see pages 1-3).

<u>Wire Color</u>	<u>Printing</u>	<u>Wire Number</u>
Red	12V BATTERY	2D

5. Starter Relay to Starter Solenoid

Obtain the large purple Starter Solenoid Feed pigtail “**S**” and attach the ring terminal to the Solenoid “**SOL**” terminal of the Starter Relay (see pages 1-3). Route this purple, “STARTER SOLENOID – S” wire (circuit 6) to the Starter, cut to length, slide on sleeve “**E**” and crimp on ring terminal “**A**”. Connect this ring terminal to the Solenoid Stud of the Starter. Obtain the large red pigtail “**X**” and attach the ring terminal to the Solenoid “**BAT**” terminal of the Starter Relay (see pages 1-3). Route this red wire to the Starter, cut to length, slide on sleeve “**E**” and crimp on ring terminal “**A**”. Connect this ring terminal to the Battery Stud of the Starter.

<u>Wire Color</u>	<u>Printing</u>	<u>Wire Number</u>
Purple	STARTER SOLENOID-S	6
RED	no printing	2F

6. Ignition Start Wire

Obtain the yellow no printing (circuit 5) wire that is already plugged into the Bulkhead Connector, this is your start circuit. Route the yellow wire to the Starter Relay and cut to length, crimp on terminal “**C**” and plug into connector “**D**”. Connect this wire to the Ignition terminal “**I**” of the Starter Relay (see pages 1-3).

<u>Wire Color</u>	<u>Printing</u>	<u>Wire Number</u>
Yellow	no printing	5

7. Alternator Output Power

Use the 6ga red wire, MegaFuse, ring internals, and shrink tube from the 510476 kit. Attach one end to the megafuses, route from there the to the alternator, cut to length, apply ring terminal and boot and attach to the Alternator output stud. (see pages 1-3).

<u>Wire Color</u>	<u>Printing</u>	<u>Wire Number</u>
Red	no printing	2B

8. Ignition Coil with Full Voltage

See pages 7 and 8 for instructions on wiring various ignition systems.

<u>Wire Color</u>	<u>Printing</u>	<u>Wire Number</u>	<u>Wire Function</u>
Pink	IGNITION FEED	3A	Ignition (1) Power when key is in run position.
Brown	no printing	7	Ignition (2) Power when key is in start/crank position.



ENGINE KIT
510783

9. Ignition Coil with Reduced Voltage

If using a points type Ignition System that requires reduced voltage, route the large pink "IGNITION FEED" wire (circuit 3A), from the Bulkhead Connector, to the Ignition feed side (see pages 1-3) of a Ballast Resistor (not provided in this kit), cut to length, and crimp on terminal "B" and plug into connector "D". Route the brown no printing wire (circuit 7), from the Bulkhead Connector, to the coil side of the Ballast Resistor and double it with the cut off portion of the large pink wire, crimp on terminal "B" and plug into connector "D". This brown wire provides voltage during crank. Route the other end of the large pink wire to the positive (+) side of the Ignition Coil and cut to length. Terminals "L" and "M" have been provided to make the connection to the Ignition Coil.

<u>Wire Color</u>	<u>Printing</u>	<u>Wire Number</u>
Pink	IGNITION FEED	3A
Brown	no printing	7

10. Electric Choke

For vehicles equipped with an Electric Choke, obtain the tan "ELECTRIC CHOKE" wire (circuit 39B). Plug this wire into the bulkhead connector in the location shown on pages 1,2, and 3. Route the other end of this wire to the Electric Choke, cut to length, install terminal "C", and insert into connector "F". You can now connect to the Electric Choke (see pages 1-3).

<u>Wire Color</u>	<u>Printing</u>	<u>Wire Number</u>
Tan	ELECTRIC CHOKE	39B

11. Water Temp Sender

Obtain the dark green "WATER TEMP SENDER" WIRE (circuit 35) which is already plugged into the Bulkhead connector. Route this wire to the Water Temperature Sender, cut to length, install terminals "C" or "H" (install sleeve "N" first if using terminal "H"), plug into connector "G" (if using terminal "C") and connect to the Water Temperature Sender (see pages 1-3).

<u>Wire Color</u>	<u>Printing</u>	<u>Wire Number</u>
Dark Green	WATER TEMP SENDER	35

12. Oil Pressure Sender

Obtain the dark blue "OIL PRESSURE SENDER" wire (circuit 31) which is already plugged into the Bulkhead connector. Route this wire to the Oil Pressure Sender, cut to length, install terminals "C" or "H" (install sleeve "N" first if using terminal "H"), plug into connector "G" (if using terminal "C") and connect to the Oil Pressure Sender (see pages 1-3).

<u>Wire Color</u>	<u>Printing</u>	<u>Wire Number</u>
Dark Blue	OIL PRESSURE SENDER	31

13. Tachometer Signal

Obtain the white "COIL --> TACH" wire (circuit 121) which is already plugged into the Bulkhead Connector, route to the negative (-) side of the Ignition Coil and connect. If using an Aftermarket Ignition System or an HEI Distributor, connect per the Manufacturer's recommendations (see pages 7-8).

<u>Wire Color</u>	<u>Printing</u>	<u>Wire Number</u>
White	COIL --> TACH	121

NOTE: Once the Bulkhead Connector has had all of its wires plugged in, the connector cavities should be sealed with dielectric grease on the terminals. Also to assure a moisture resistant seal, silicone can be applied to seal the outside of the connector.



www.americanautowire.com 856-933-0801

ENGINE KIT
510783

510783 Engine harness installation instructions:

Ignition systems wiring:

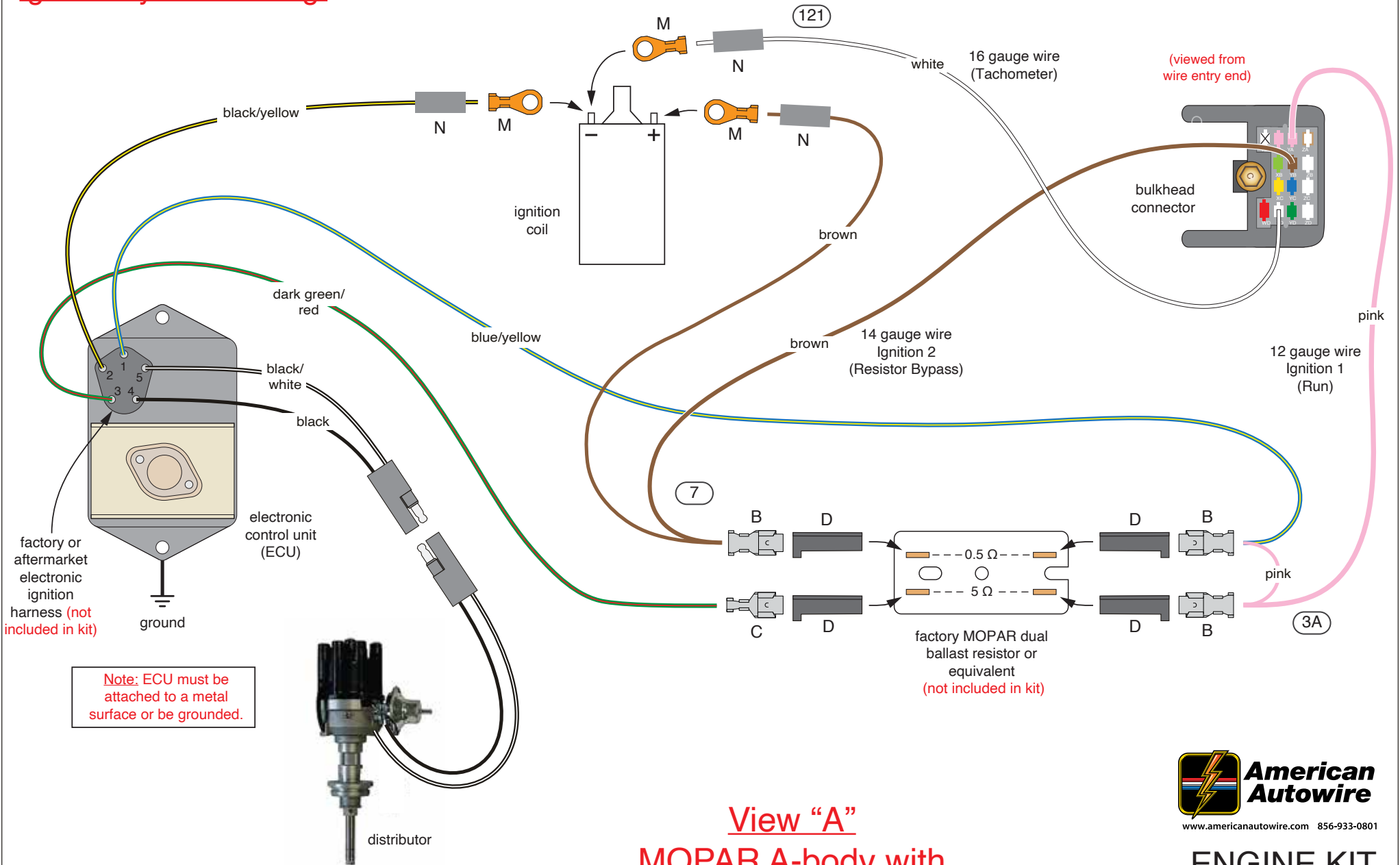

Note: ECU must be attached to a metal surface or be grounded.

View "A" MOPAR A-body with MOPAR electronic ignition



ENGINE KIT 510783

510783 Engine harness installation instructions:

Ignition system wiring:

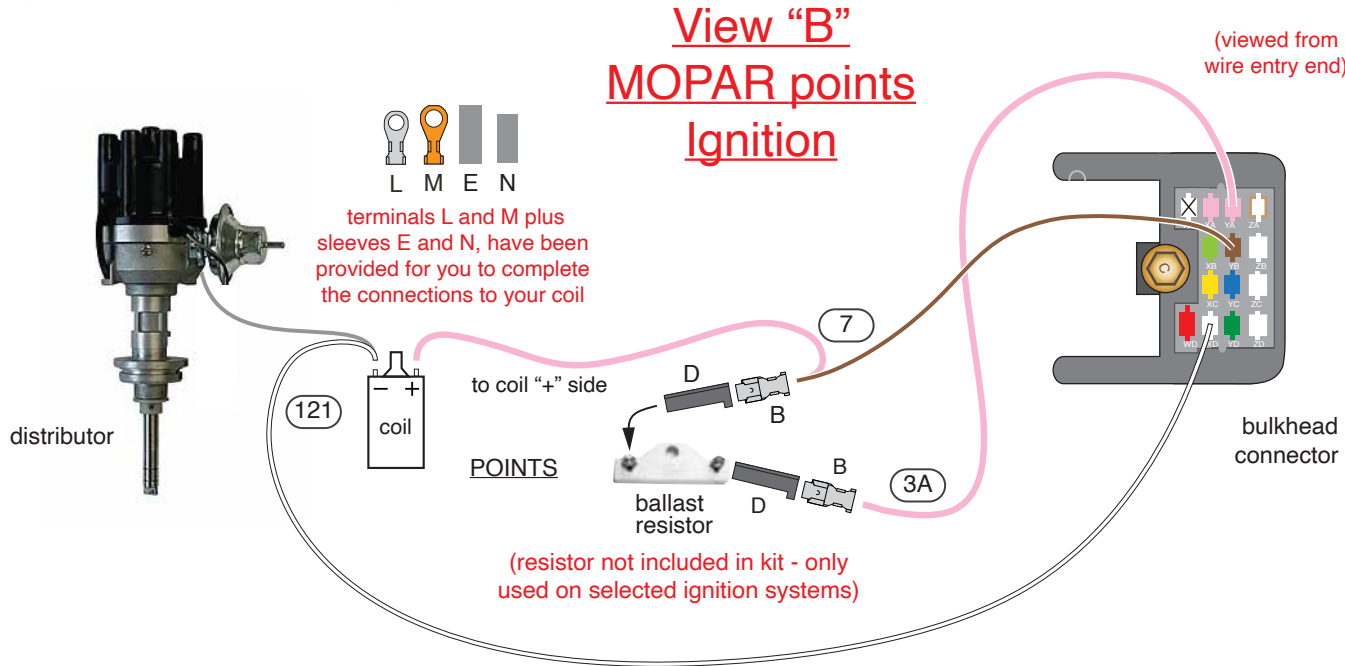

View "C" with HEI distributor

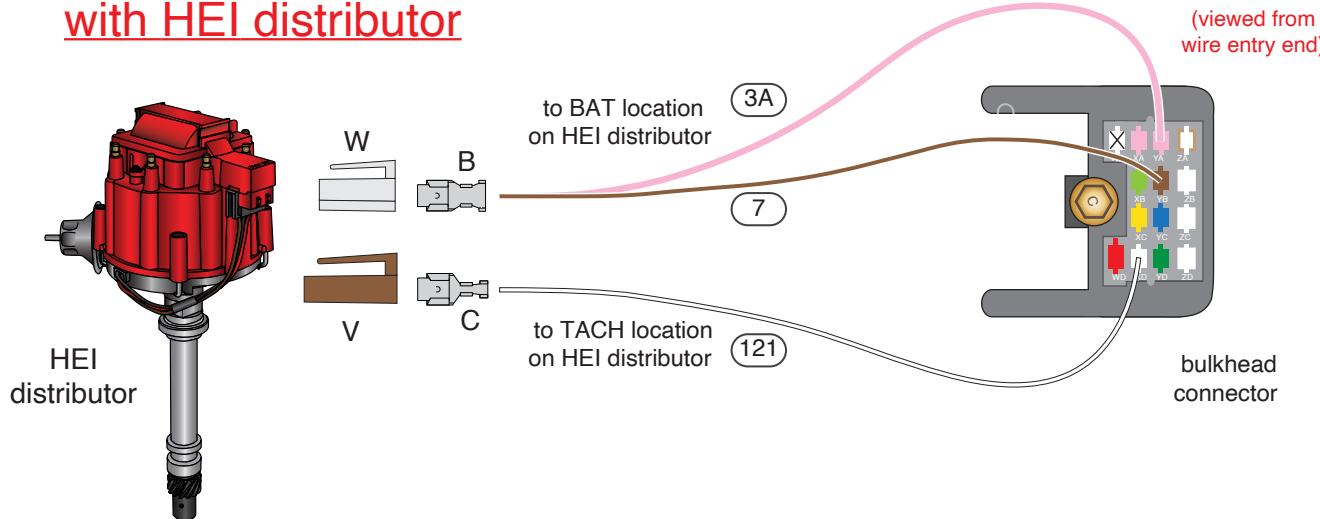

Ignition system wiring:

OTHER IGNITION TYPES

FOR OTHER TYPES OF IGNITION SYSTEMS AND/OR EFI APPLICATIONS:

The Pink and Brown ignition wires may be connected together and used as a keyed 12(+) power feed to your ignition box or EFI computer control harness or computer.

Please note: **These wires are not fused.** Please consult the instructions for your ignition system or EFI harness to confirm if an in-line fuse is required.

Finally: The pink and brown wires **must be used together** in order for their to be power when the key is in the run and crank position.



www.americanautowire.com 856-933-0801

ENGINE KIT
510783

92972813 Rev 1.0 10/19/2023

A  (1)
 (144.0" 6 Gauge charge wire)

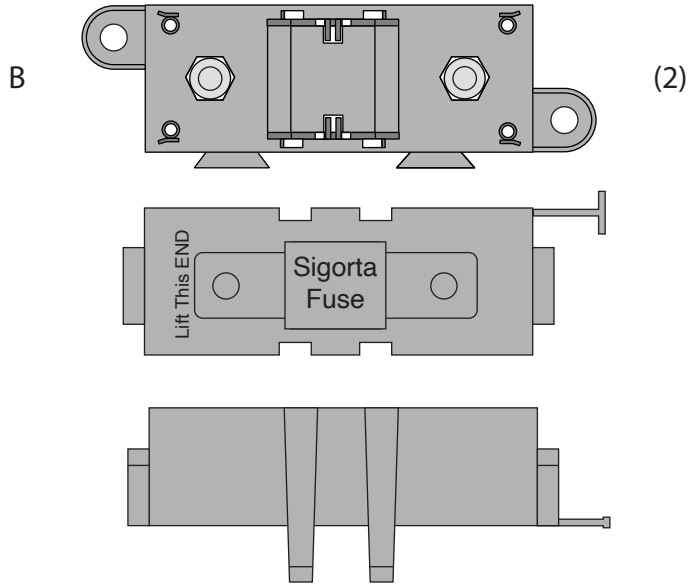

1. On this page, you will find the wire, fuse bodies, fuses, boot, ring terminals, and shrink tubing (items A through K) that are necessary to connect your alternator and main power feed for your new AAW wiring kit. Please be sure that all of the necessary components are present before starting this portion of your installation. If anything is missing, stop what you are doing and contact AAW at the number listed below right away.

2. On page 2, you will find directions for building the 2 Megafuse assemblies (items B,C and D) into one unit.

3. On page 3, you will find an overall concept of how to connect the Megafuse assemblies to your starter solenoid, alternator and main power feed of your new wiring system.

4. On page 4, you will find tips on building your charging circuit wires and assembling them and the main panel power feed wire to the Megafuse assemblies.

(Megafuse body, cover and two M8 x 1.25 nuts / lock washers)

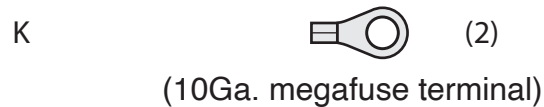
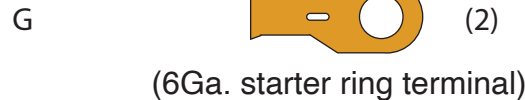
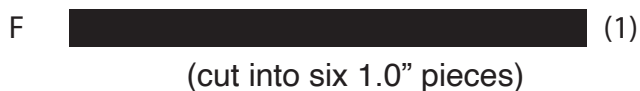
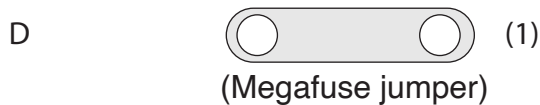
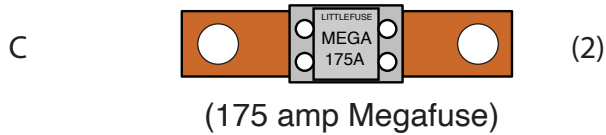

PART #

510476

Z

DESCRIPTION:

**Alternator and Main Power
Connection Kit
Various Applications**

92972153 instruction sheet rev 0.1 6/24/2019

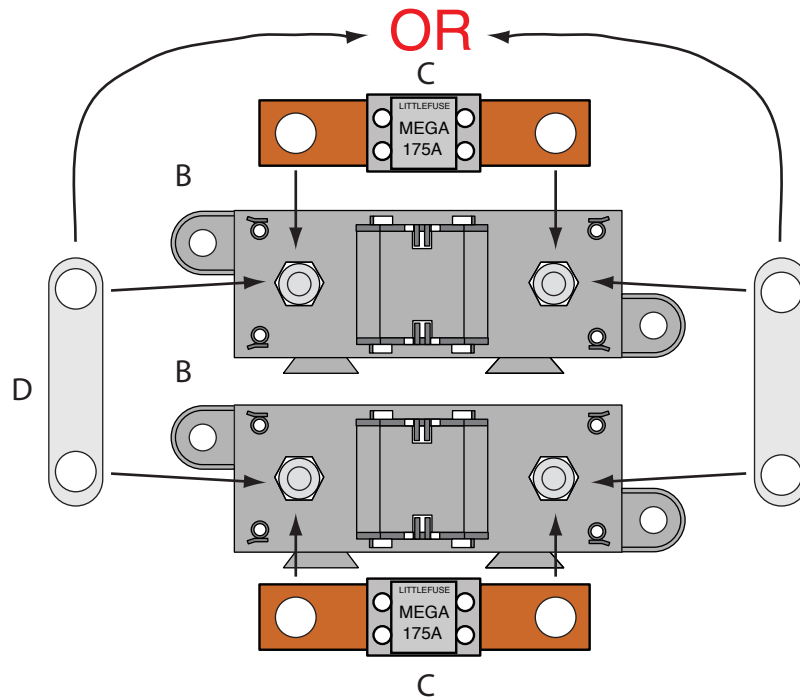

Assembling the (2) Megafuse assemblies

NOTE: Find a suitable place, as close to the battery power source as possible, under the hood of your vehicle to mount the completed Megafuse assemblies. Keep in mind that you have 12 feet of 6Ga. charging wire, and that the main power feed coming from your panel or bulkhead connection must also be able to reach the assembly.

1. Take the two Megafuse bodies and covers (items B) and snap them together. Remove the 4 nuts and lock washers from the studs on the fuse body assemblies.
2. Install the Megafuse jumper (item D above) over two of the studs on the Megafuse bodies. It is very important that the jumper **MUST BE** assembled on the side that is going to connect to your main power connection (starter solenoid or battery feed).
3. Notch top cover to clear jumper D as shown at right.
4. Snap one 175amp fuse (items C) onto the studs of each of the two Megafuse bodies (items B), over the jumper, then loosely re-attach the 4 nuts and lock washers back onto the assembled Megafuses. The fuse assemblies are ready to install into your vehicle.

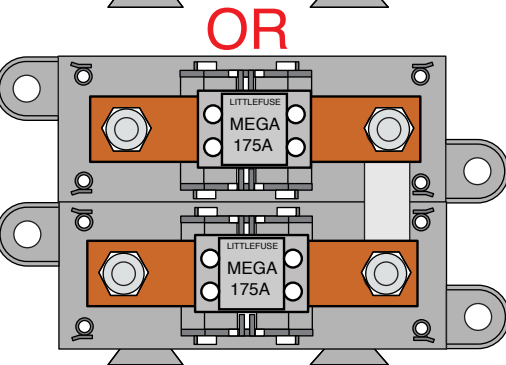
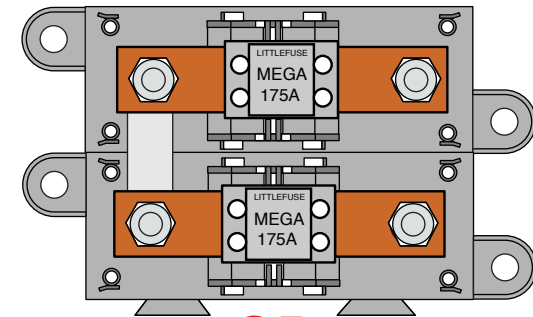

Assembled Megafuses

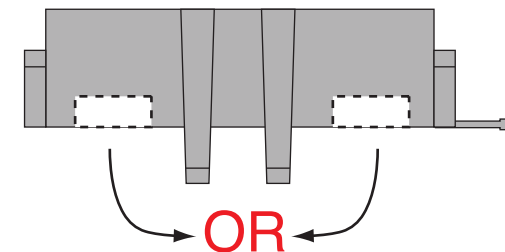

Notched Cover

PART #

510476

Z

DESCRIPTION:

**Alternator and Main Power
Connection Kit
Various Applications**

92972153 instruction sheet rev 0.1 6/24/2019

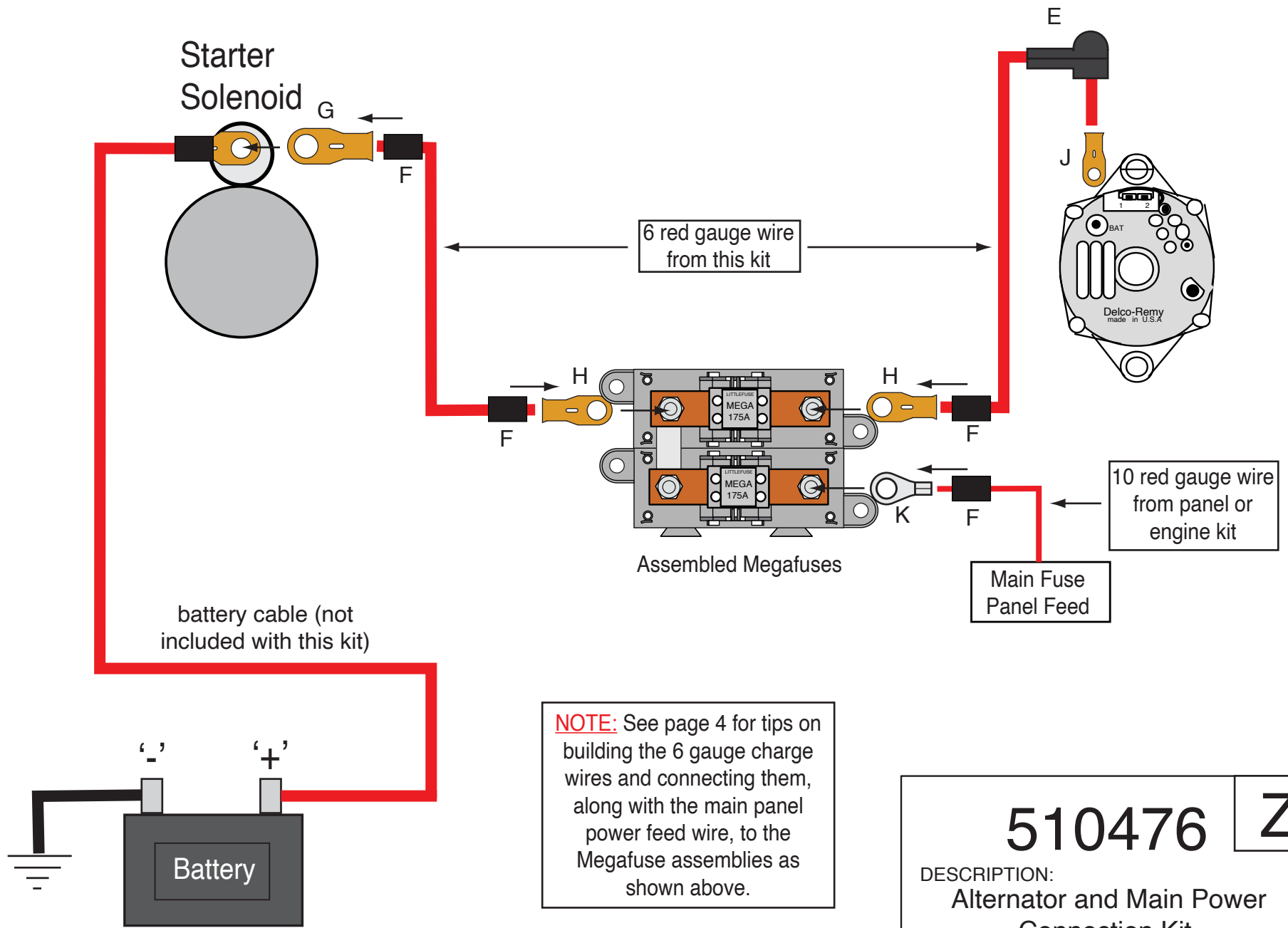

NOTE: See page 4 for tips on building the 6 gauge charge wires and connecting them, along with the main panel power feed wire, to the Megafuse assemblies as shown above.

<h1>510476</h1>	Z
<p>DESCRIPTION: Alternator and Main Power Connection Kit Various Applications</p>	
<p>92972153 instruction sheet rev 0.1 6/24/2019</p>	

Building the 6Ga. charge wires and connecting them and the main panel power feed wire to the Megafuse assemblies:

NOTE: Make sure that your battery is disconnected! You will need to install the preassembled Megafuses from page 2 in your vehicle to start this part of the installation.

1. Pre-cut item F shrink tubing into (6) 1.00" - 1.25" pieces.
2. Take the 12-foot piece of 6Ga. red wire from this kit and route it from your starter (or other battery feed) over to the area where you have mounted your Megafuse and cut it to length. Strip the insulation on each end back 1/2". Install 2 pieces of shrink tubing F onto the wire. At the starter end, crimp and solder (1) of terminal G onto the wire. At the Megafuse end, crimp and solder (1) of terminal H onto the wire. Slide the shrink tubing over the terminals and heat it up to shrink it down.
3. Take the remaining portion of the 12-foot piece of 6Ga. red wire from this kit and route it from your alternator over to the area where you have mounted your Megafuse and cut it to length. Strip the insulation on each end back 1/2". Install 1 piece of shrink tubing F onto the wire. At the alternator end, slip on boot E as shown on page 3, then crimp and solder (1) of terminal J onto the wire. At the Megafuse end, crimp and solder (1) of terminal H onto the wire. Slide the shrink tubing over terminal H and heat it up to shrink it down.
4. Take the 10Ga. red main power feed wire from your engine or panel sub-kit and route it over to the area where you have mounted your Megafuse and cut it to length. Strip the insulation back 3/8". Install 1 piece of shrink tubing F onto the wire, then crimp and solder (1) of terminal K onto the wire.
5. Remove the 4 loosely tightened nuts and lock washers from the assembled Megafuses, then using the drawing on page 3 as a guide, install your pre-assembled wires from steps 2-4 above. Re-install the 4 nuts and lock washers onto the assembled Megafuses and tighten them down. This part of your installation is now complete.

510476

Z

DESCRIPTION:

**Alternator and Main Power
Connection Kit
Various Applications**

92972153 instruction sheet rev 0.1 6/24/2019

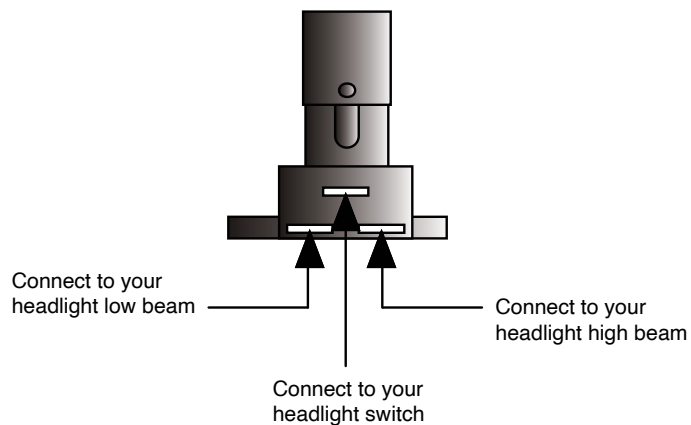

Connect the Dimmer Switch wires as shown above.

1. The top center terminal of the Dimmer Switch is connected to the Headlight switch.
2. The terminal on the right side is connected to your headlight high beam terminal.
3. The terminal on the left side is connected to your headlight low beam terminal.



**American
Autowire**

www.americanautowire.com 856-933-0801

PART #

500042

DESCRIPTION:

DIMMER SWITCH

92964573 Rev 3.1 12/5/2014

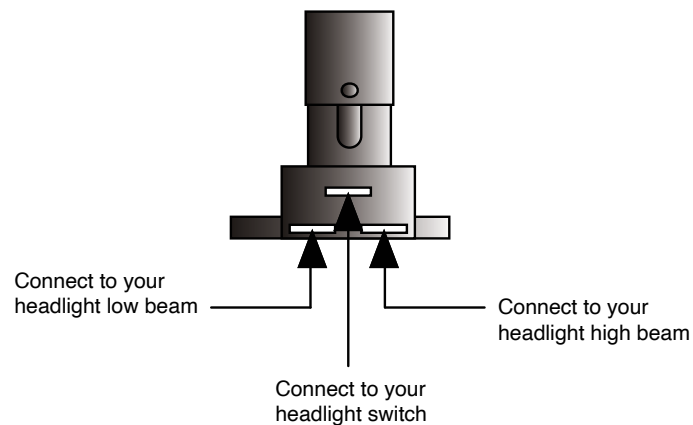

Connect the Dimmer Switch wires as shown above.

1. The top center terminal of the Dimmer Switch is connected to the Headlight switch.
2. The terminal on the right side is connected to your headlight high beam terminal.
3. The terminal on the left side is connected to your headlight low beam terminal.



**American
Autowire**

www.americanautowire.com 856-933-0801

PART #

500042

DESCRIPTION:

DIMMER SWITCH

92964573 Rev 3.1 12/5/2014